

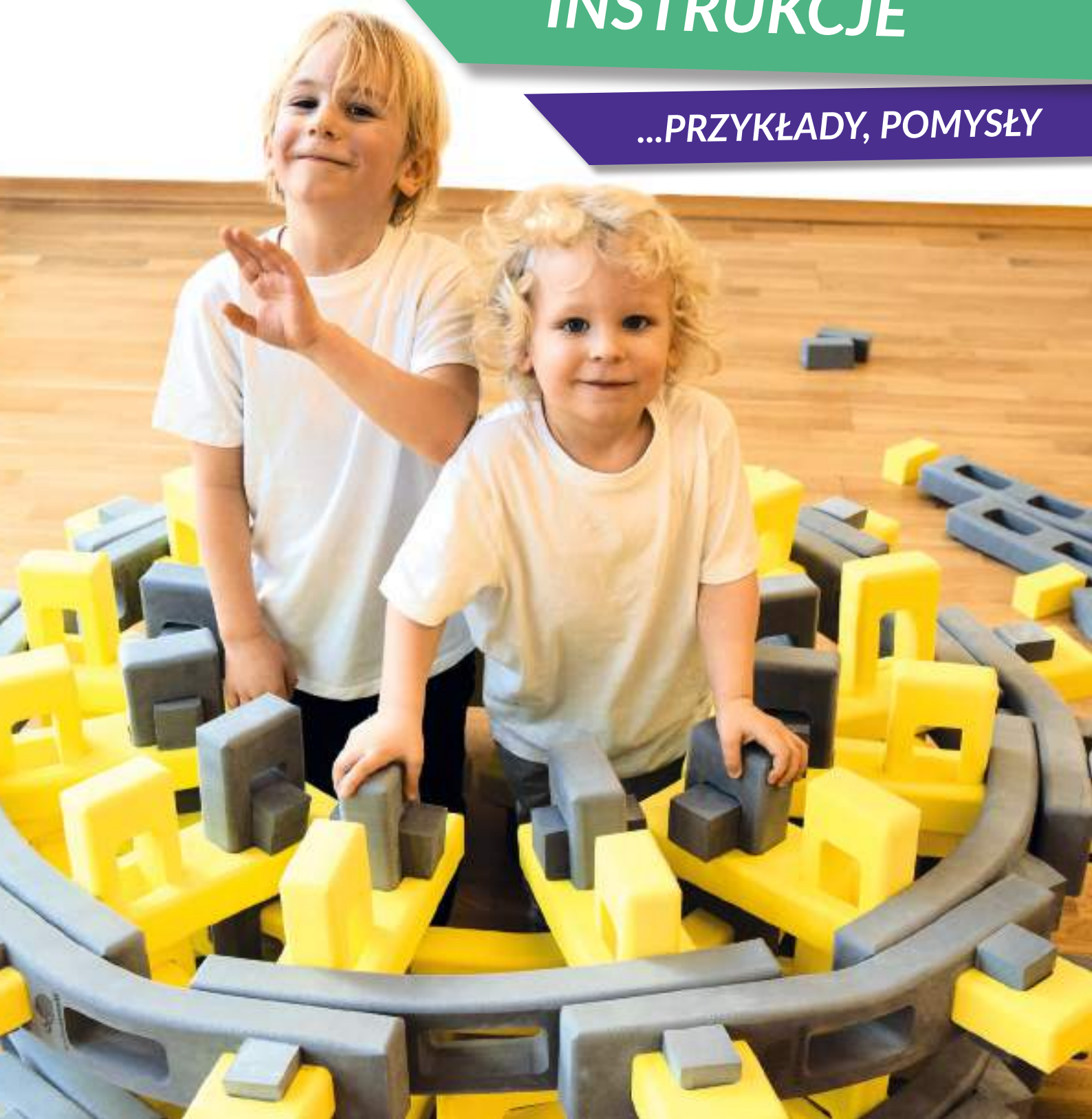

**PERFECT**

# INSTRUKCJE

...PRZYKŁADY, POMYSŁY



## WYGINAJ, PRZEKRĘCAJ, PRZEKŁADAJ...



## ...ŁĄCZ, BLOKUJ, USZTYWNIJ





## BUDUJ Z WYOBRAŹNIĄ!

Przygotowaliśmy 29 instrukcji o różnym poziomie trudności. Niektóre z nich zawierają bardzo szczegółowe etapy budowy, inne – tylko poszczególne kroki ułatwiające osiągnięcie celu.

Pianka, z której wykonane są klocki jest miękka i elastyczna, co pozwala na bardzo różne zastosowanie. Klocki można dowolnie wyginać i wykręcać, ponieważ ostatecznie „powrócą” do pierwotnego kształtu.

Elementy wypełniające otwory klocków PERFECT™ mogą pełnić kilka istotnych funkcji. Najważniejsza z nich, to możliwość łączenia dwóch klocków. Druga to blokowanie – wkładając element pionowo lub poziomo w otwory klocka, zapobiegiesz „rozsuwaniu” się konstrukcji. Kostki są także ozdobnikami i świetnie usztywniają duże klocki będące podstawą większej budowli.

Większość, spośród zaprezentowanych przez nas budowli to propozycje, które wskazują drogę do realizacji swoich własnych pomysłów! Np. ciuchcia (str.41) powstała z kilku większych elementów. Jeśli wykonasz ich więcej, mogą posłużyć do zbudowania zamku, domku lub zegara Big Ben, jaki widać po lewej stronie tekstu. Z kolei auto ze strony 12 da się przerobić na samolot, ciężarówkę lub inny dwuosobowy pojazd kosmiczny.

Mamy nadzieję, że nasze propozycje nie tylko posłużą Wam do wiernego odtwarzania kolejnych kroków, ale przede wszystkim pozwolą lepiej poznać klocki i cieszyć się ich możliwościami!

Udanej zabawy!  
Zespół Mammutico®

Perfect 80

NAZWA ZESTAWU,  
Z KTÓREGO MOŻNA  
WYKONAĆ BUDOWLĘ

# MOTOR



48



12



LICZBA **DUŻYCH** KŁOCKÓW  
POTRZEBNYCH DO BUDOWY

LICZBA **MAŁYCH** KŁOCKÓW  
POTRZEBNYCH DO BUDOWY

WYGLĄD BUDOWLI



+7

DODAJ 7 **DUŻYCH** KŁOCKÓW  
DO KONSTRUKCJI

KIERUNEK LUB  
WSKAZÓWKA DZIAŁANIA



+8

DODAJ 8 **MAŁYCH** KŁOCKÓW  
DO KONSTRUKCJI

POWIĘKSZENIE UŁATWI  
CI PRACĘ



!

NIETYPOWA SYTUACJA.  
ZWRÓĆ UWAGĘ NA  
SPOSÓB UMIESZCZENIA LUB  
WYGIĘCIA KŁOCKA

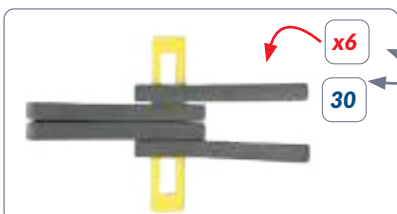

x6

30

WYKONAJ 6 TAKICH  
SAMYCH KONSTRUKCJI.  
BĘDZIESZ POTRZEBOWAĆ DO  
TEGO 30 **DUŻYCH**  
KŁOCKÓW

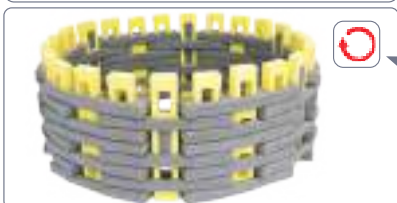

↻

OBRÓĆ BUDOWLĘ  
LUB ZMIENŃ JEJ POZYCJĘ

# SPIS TREŚCI

## PERFECT 40

6 .....	Hulajnoga
7 .....	Stołek
8 .....	Helikopter
10 .....	Samolot
11 .....	Odkurzacz
11 .....	Ważka
12 .....	Auto
14 .....	Szczudła
16 .....	Mały domek
17 .....	Żółw
17 .....	Ognisko

## PERFECT 80

18 .....	Domek jednoosobowy
22 .....	Namiot tipi
24 .....	Koło zębate
26 .....	Krzeseło z oparciem
28 .....	Motor

## PERFECT 160

31 .....	Wieża
32 .....	Tunel
34 .....	Igloo
38 .....	Koło wielofunkcyjne
41.....	Ciuchcia z wagonem
44.....	Stadion Narodowy
48 .....	Kula
53 .....	Wieża do sufitu
54 .....	Łuk Triumfalny



Perfect 40

# HULAJNOGA

 **18**  **0**



**1.** 12

**2.** +2

**3.** 4

**4.**



Perfect 40

# STOŁEK



26



12



1.

4



2.

+6



3.

+2

+6

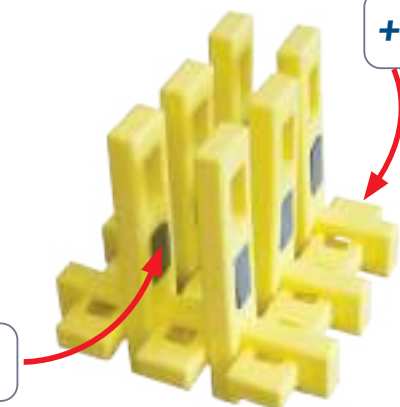

4.

+6

+6

+2

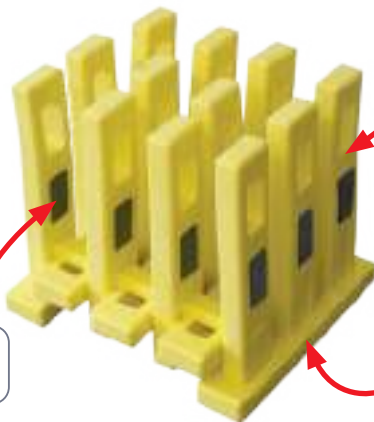

5.

+3



6.

+4



Perfect 40

# HELIKOPTER



36



22



1.

12

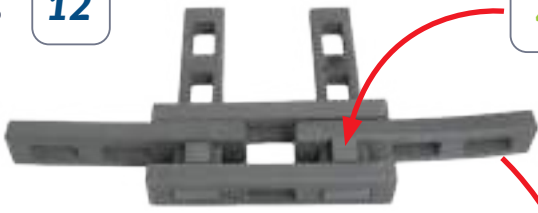

4

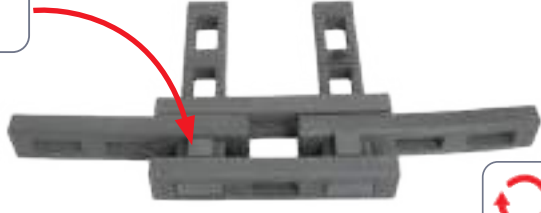

2.

+4

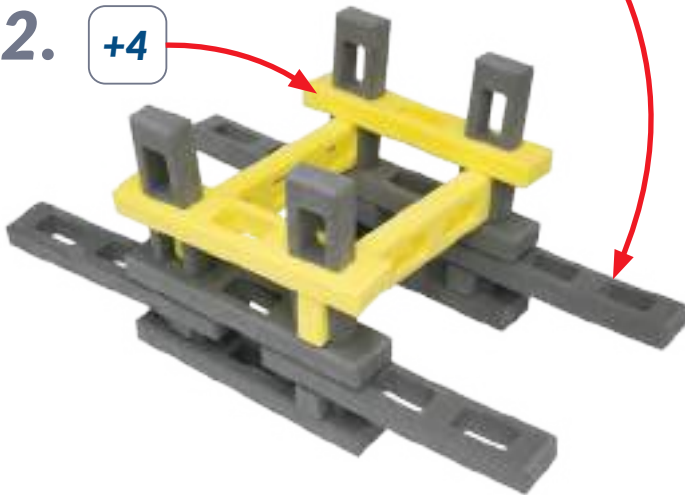

3.

9



4.

+4

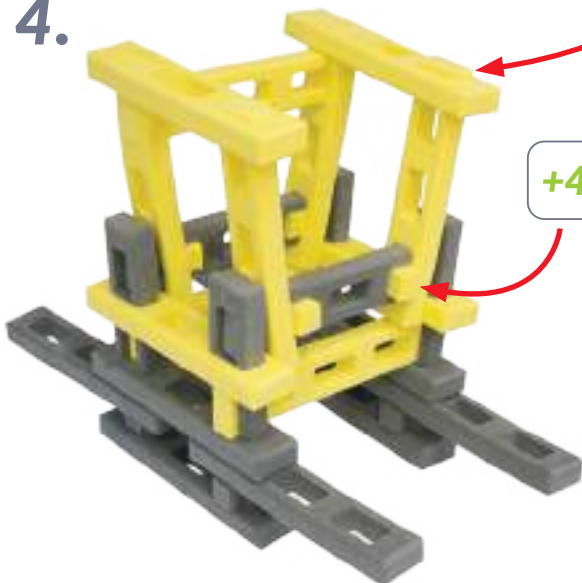

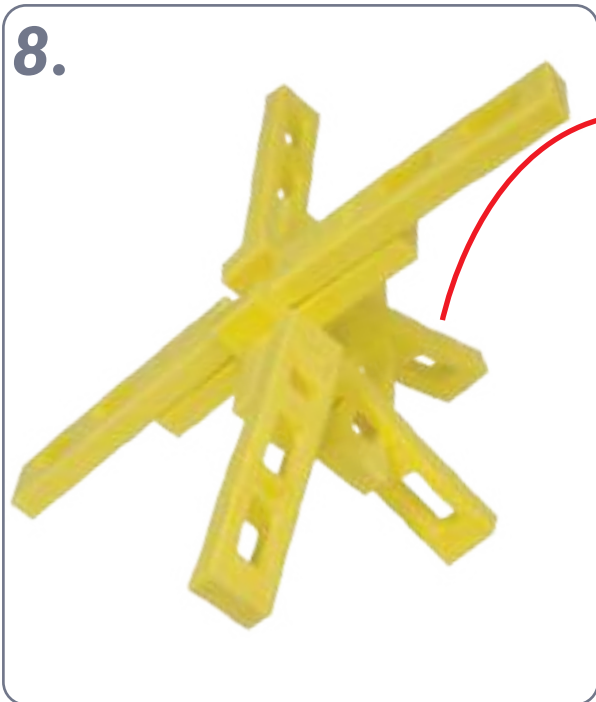
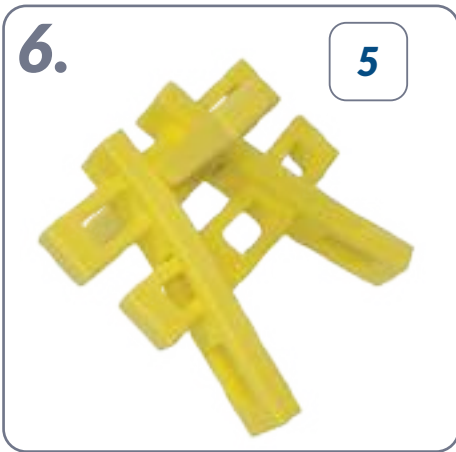
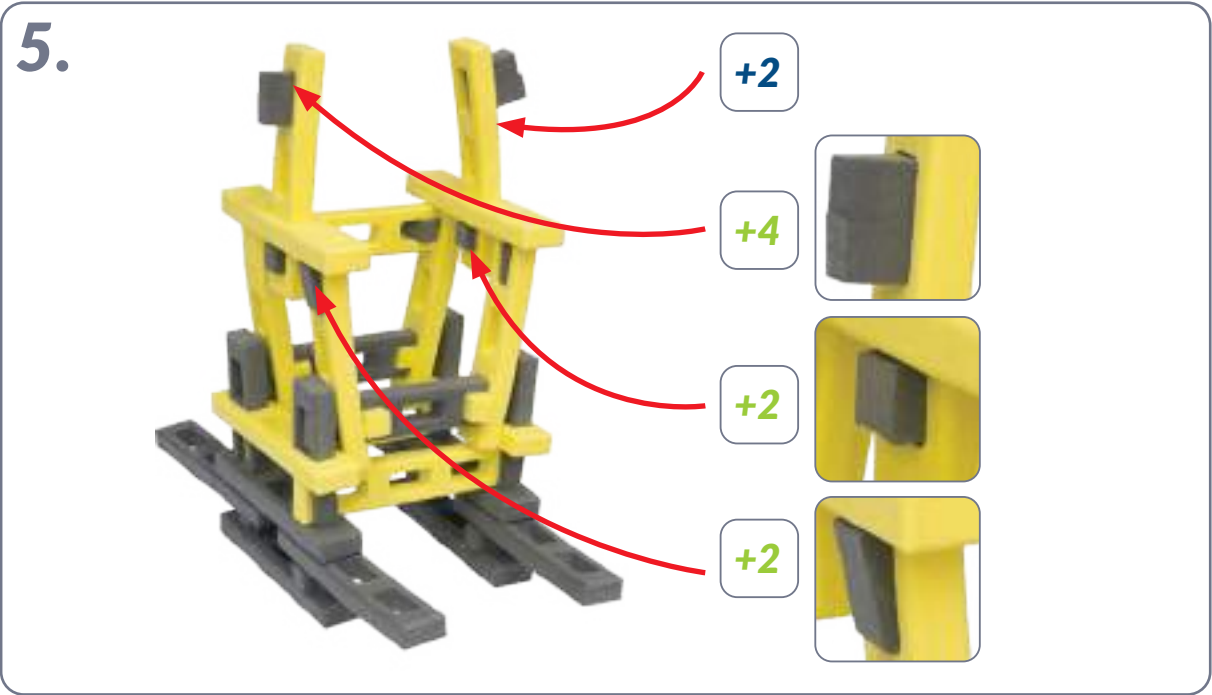

Perfect 40

# SAMOLOT

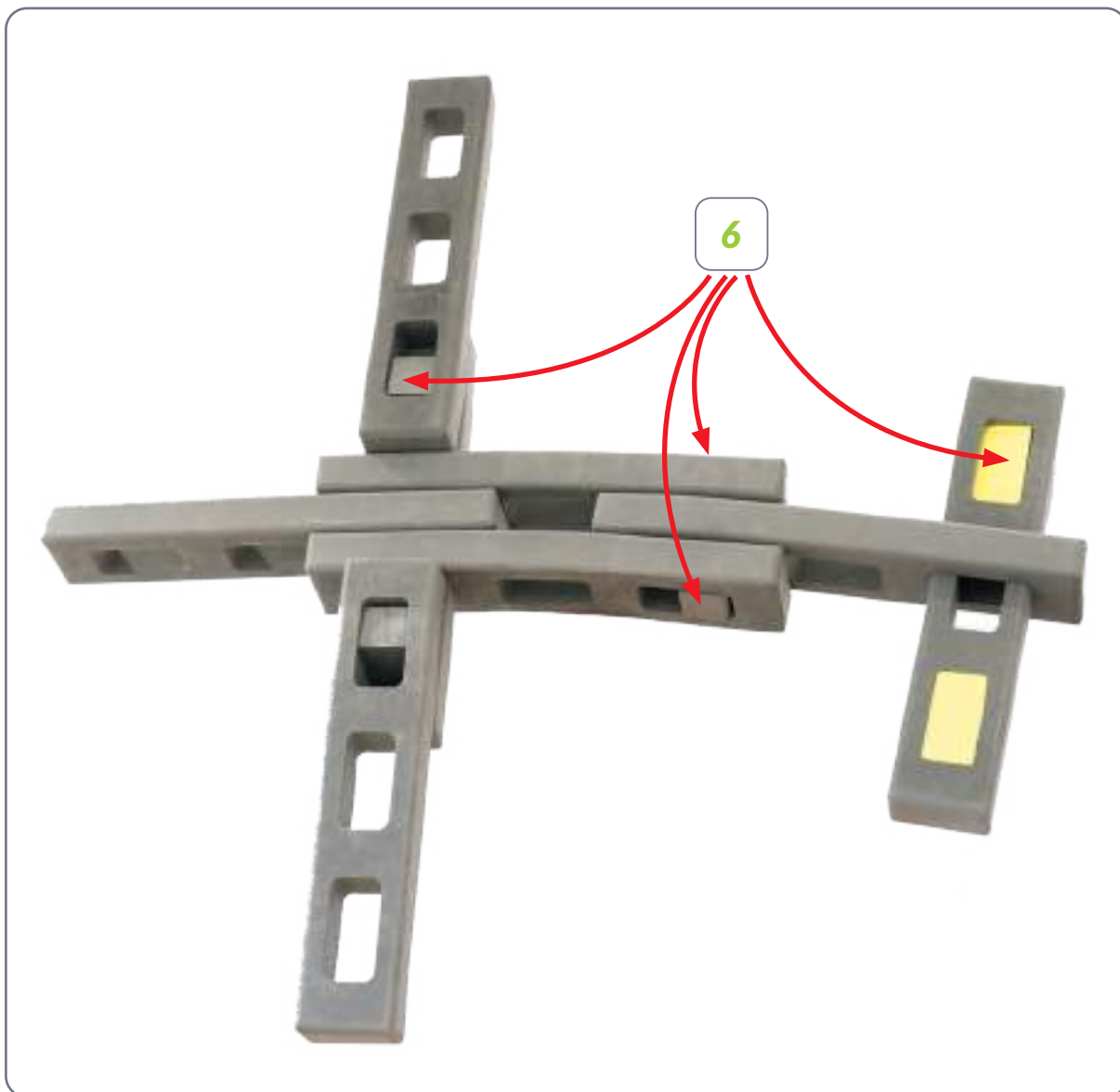

# ODKURZACZ

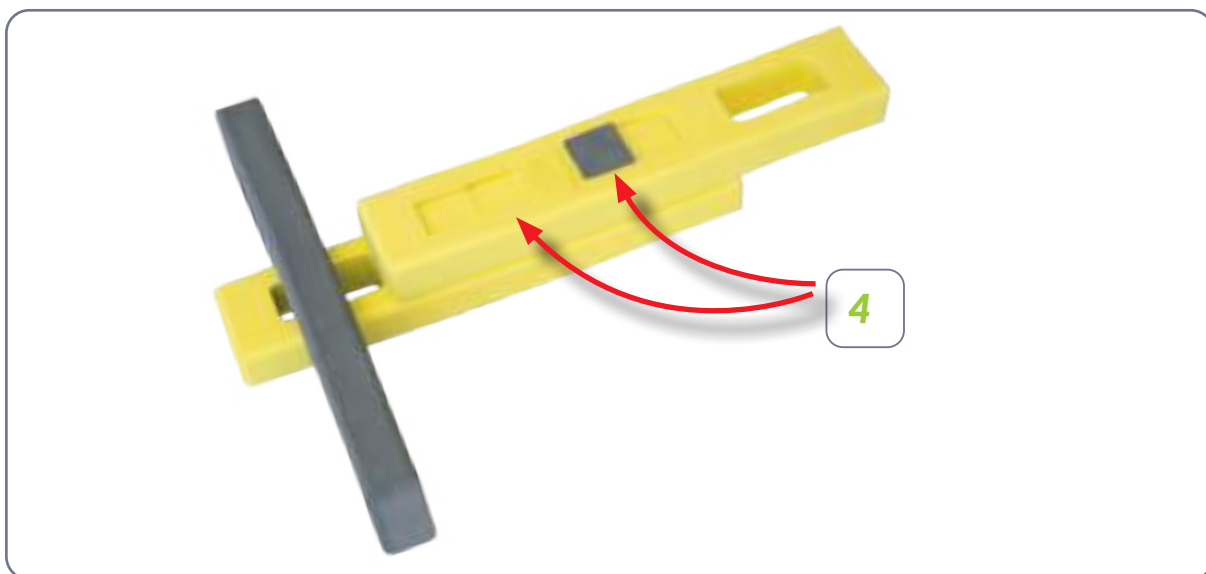

# WAŻKA

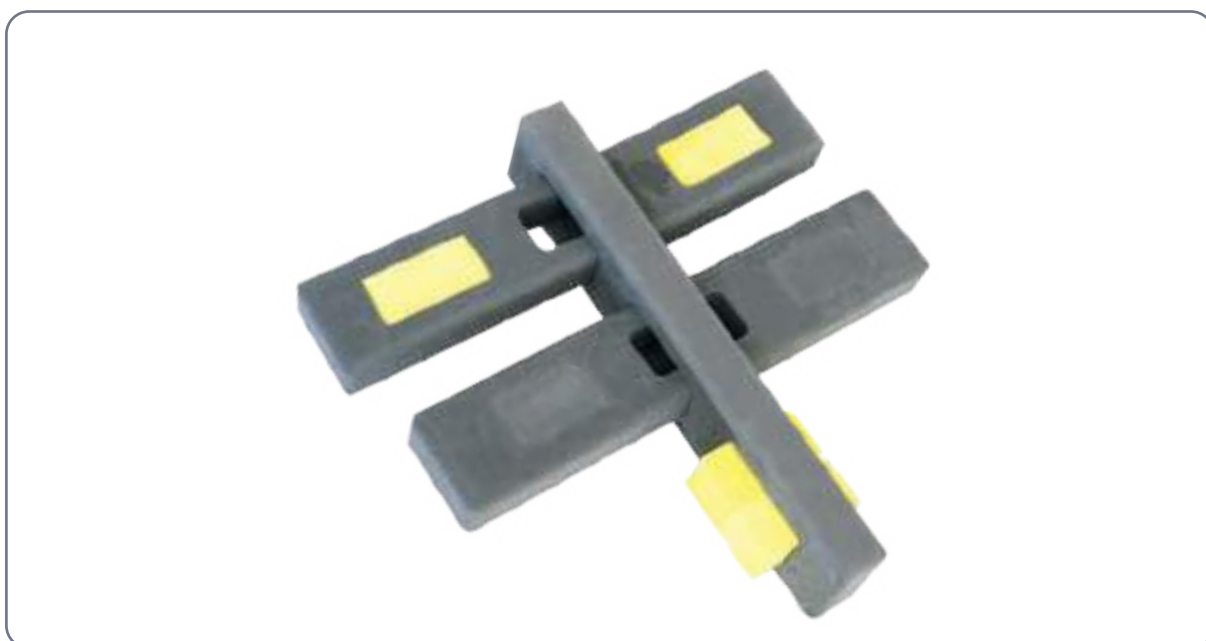

# AUTO



32



12



1.

8

3



2.

8

2



3.

6



4.

!

!

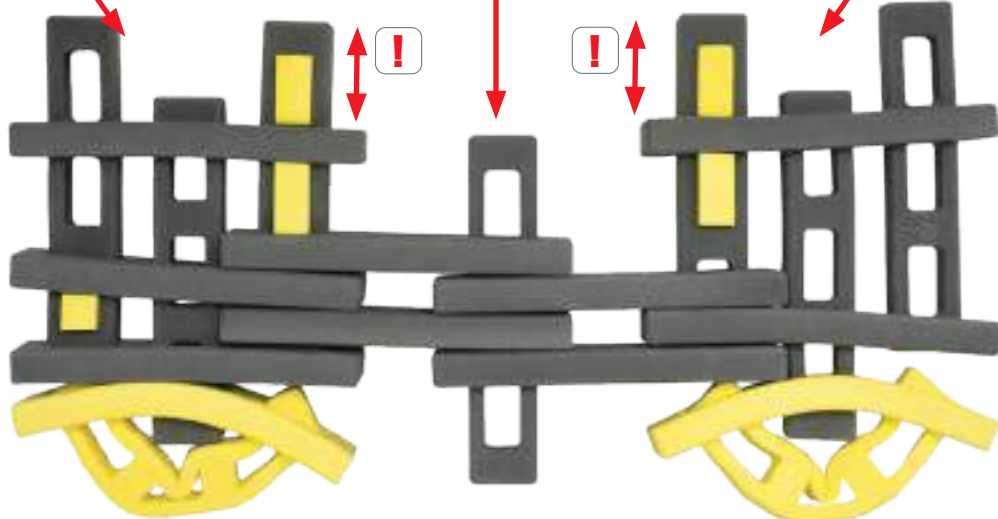

5. x2



6. +5

+7

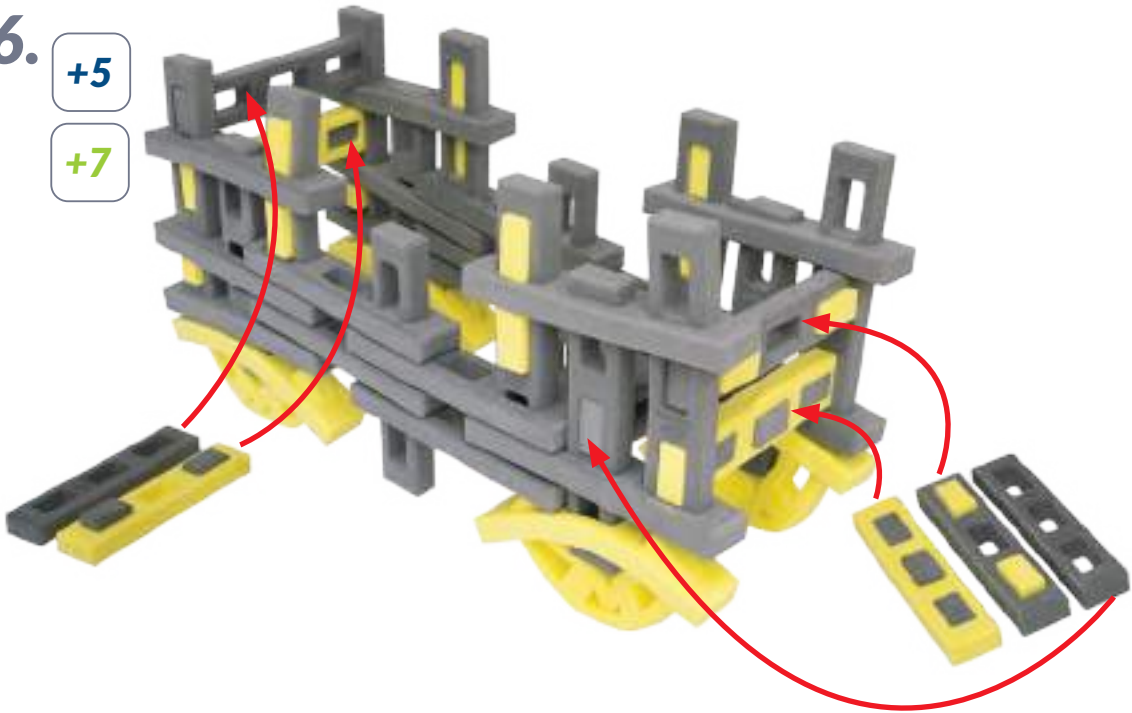

7. +7

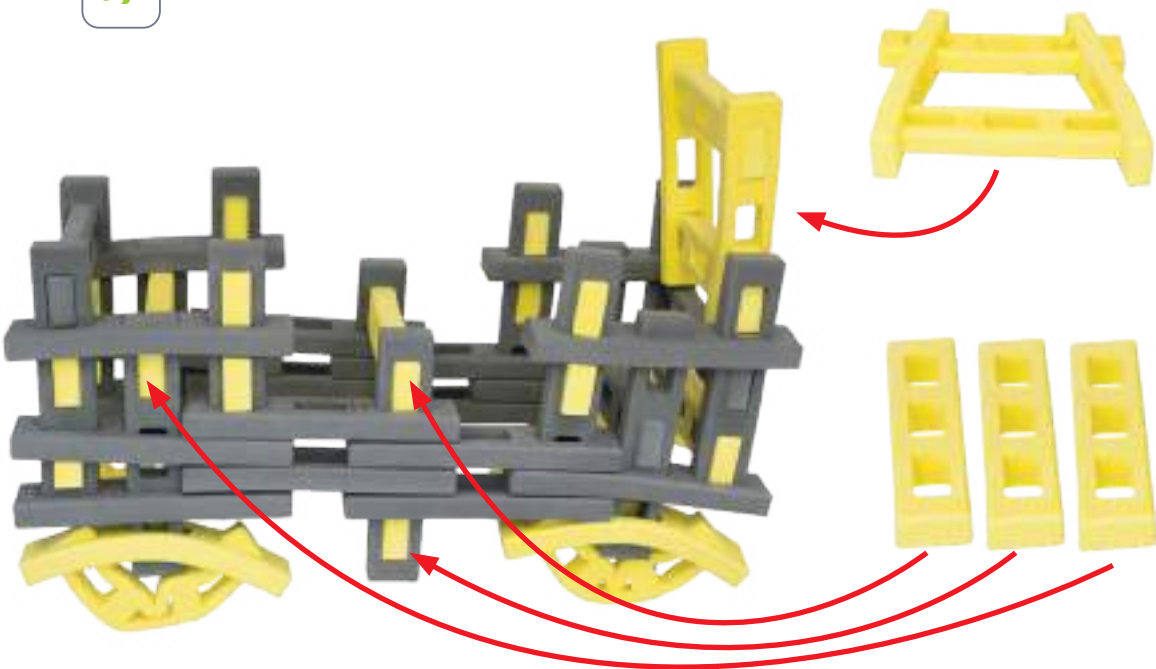

# SZCZUDŁA

 **16**       **12**





1.  **2**       **4**



2.  **+3**       **x2**

 **+4**

3.  **+2**

 **+4**

4.  **2**

5.

+2



6.

+2



Perfect 40

# MAŁY DOMEK



24



9



Perfect 40

# ŻÓŁW



# OGNISKO



Perfect 80

# DOM JEDNOOSOBOWY



50



28



1. 17



2.



3.



4.

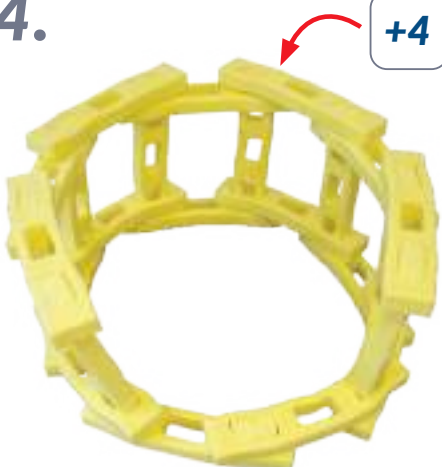

5.

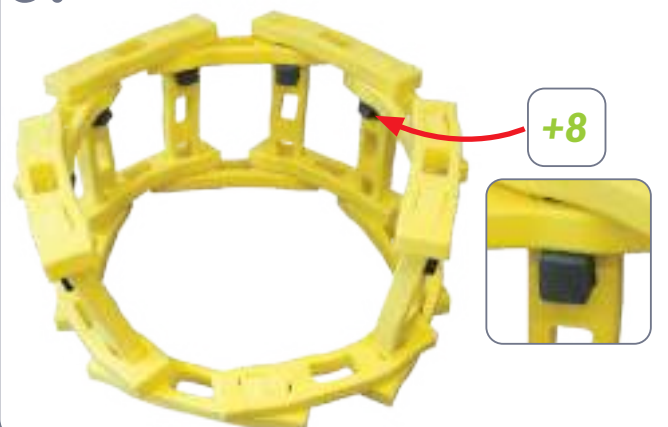

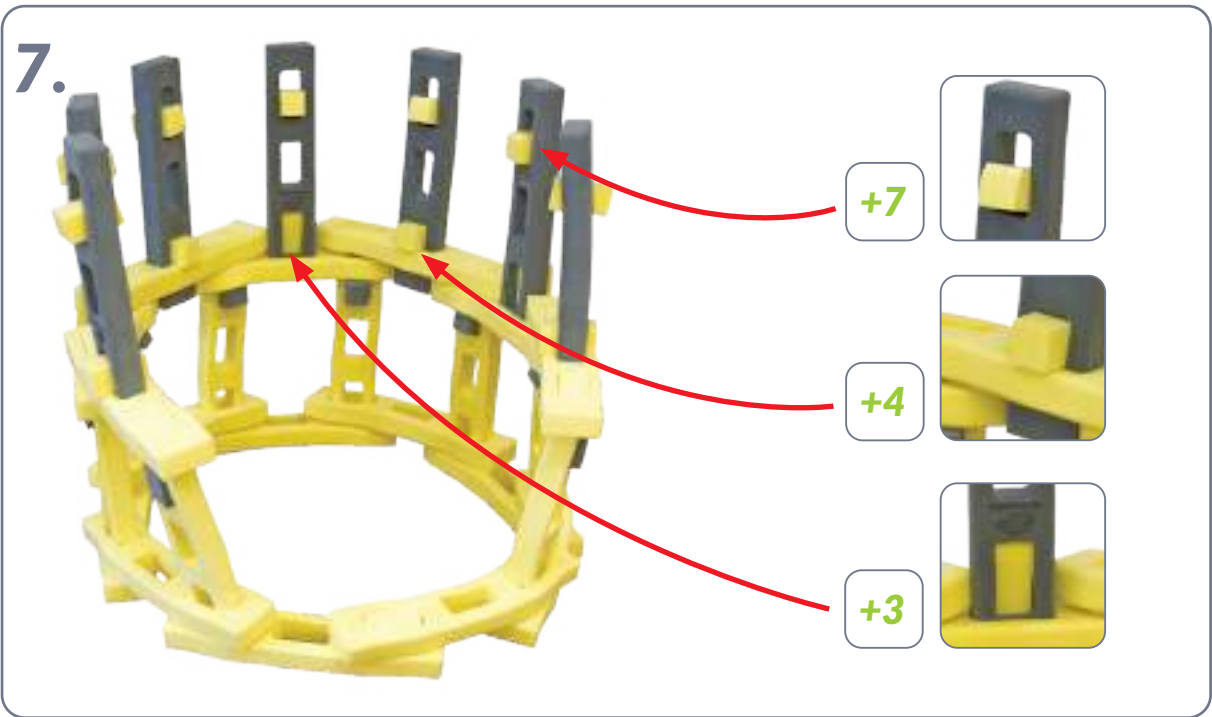

10.



+1



11.

15



12.

+5



13.



ZESTAW KOMPATYBILNY

# MAMMUTICO BASIC

Dzięki połączeniu zestawów PERFECT oraz BASIC możesz zbudować jeszcze więcej fantastycznych konstrukcji!

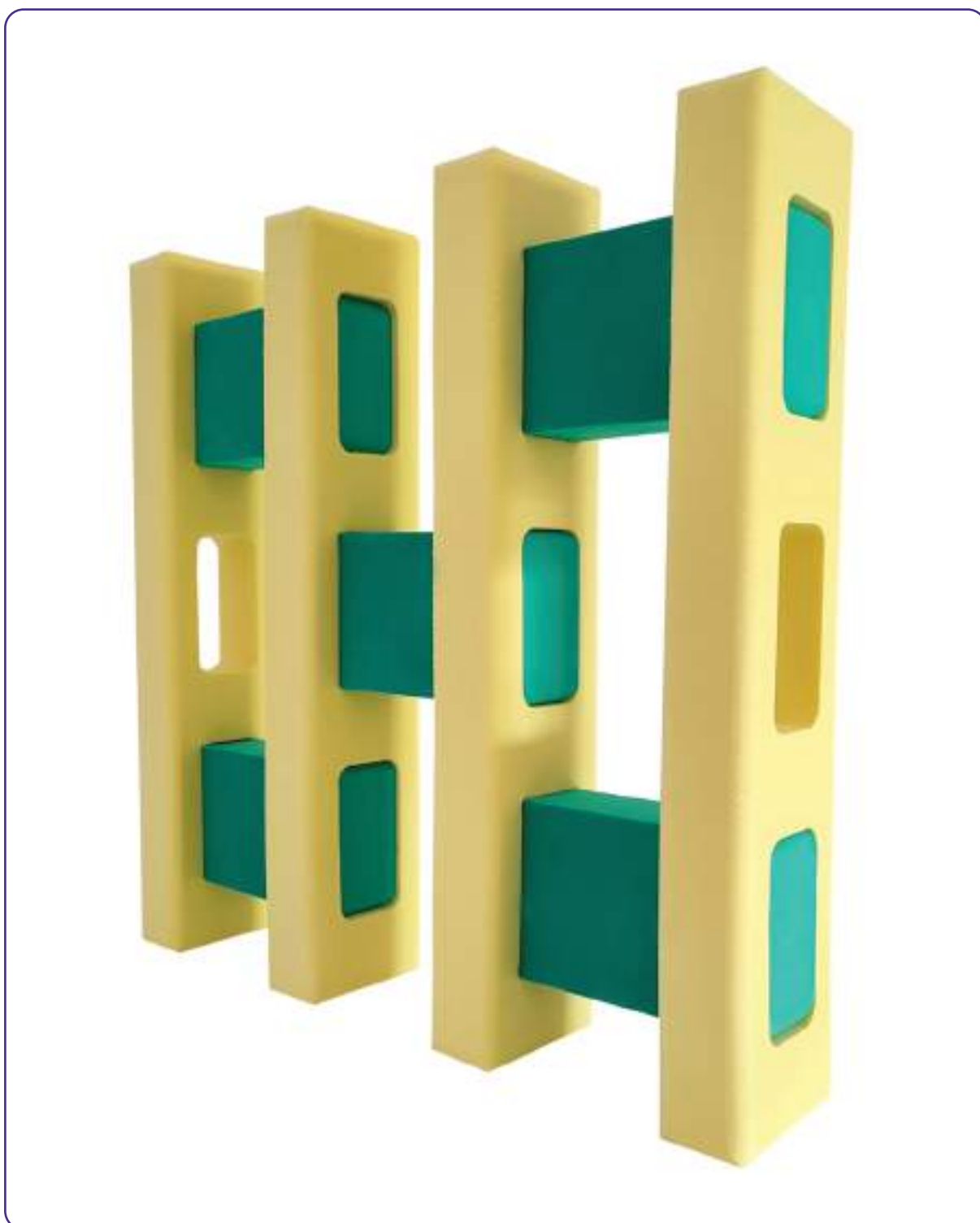

# NAMIOT TIPI



78



0



1.

52

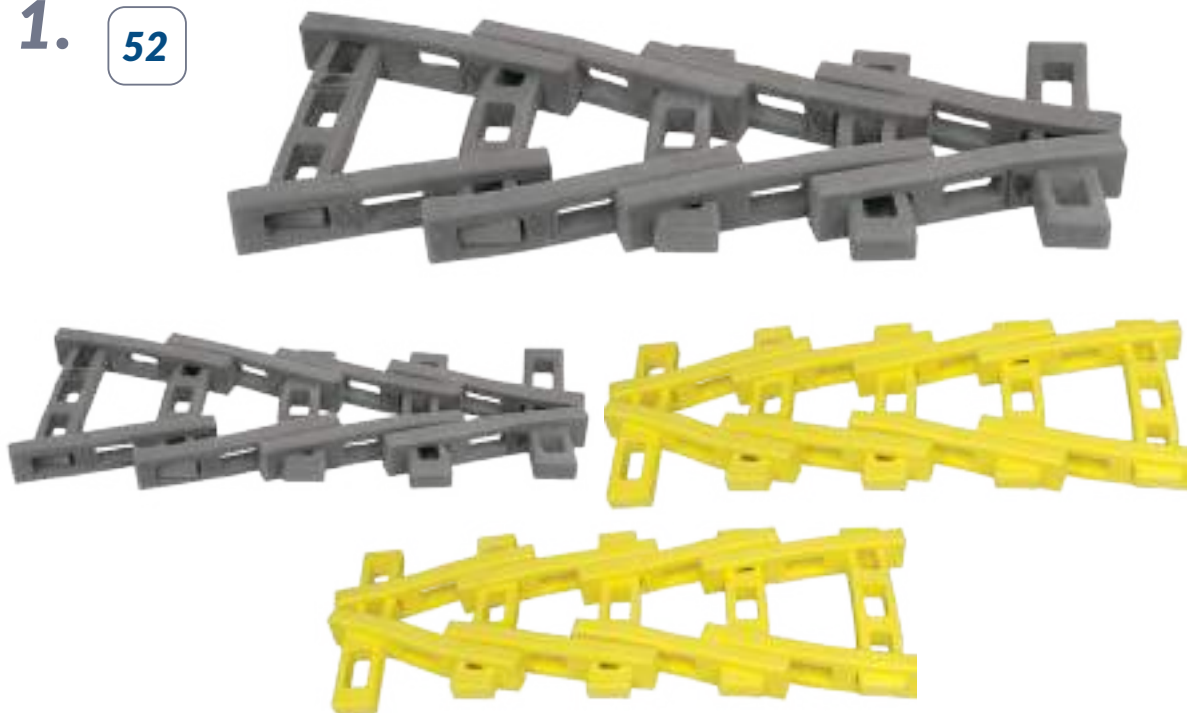

2.

+4

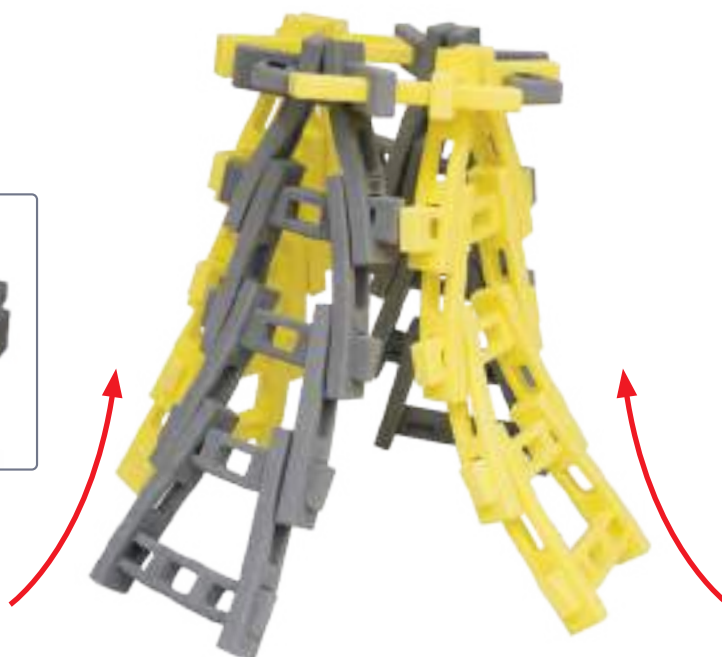

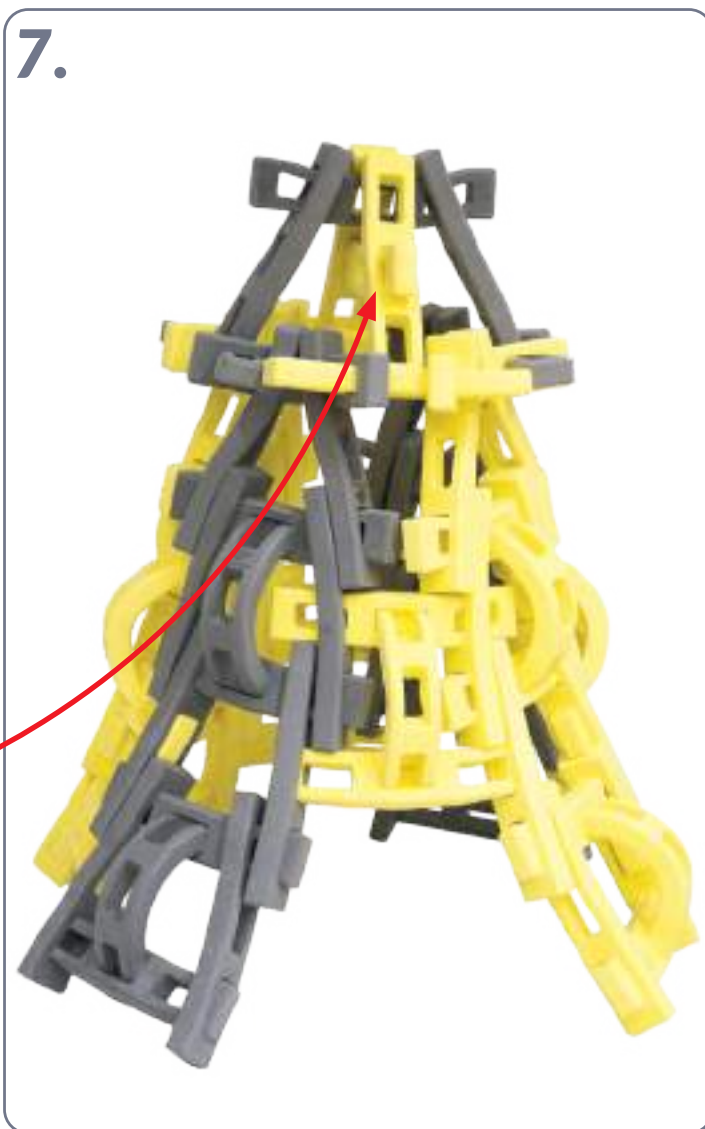
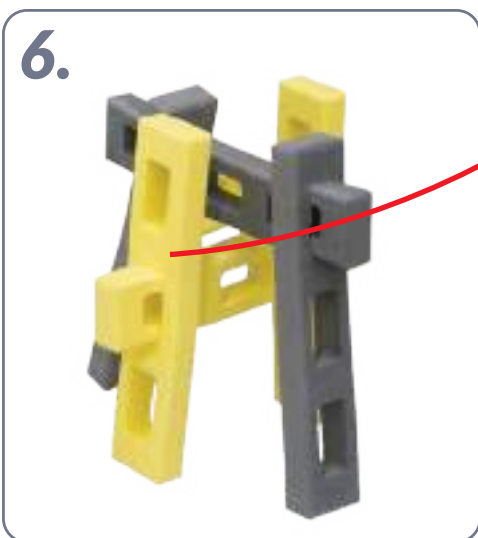
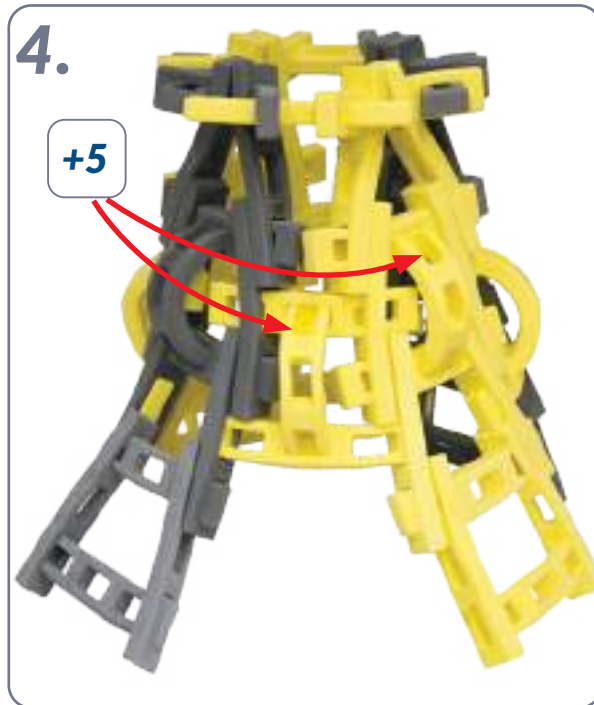

# KOŁO ZĘBATE



76



48



1. 13

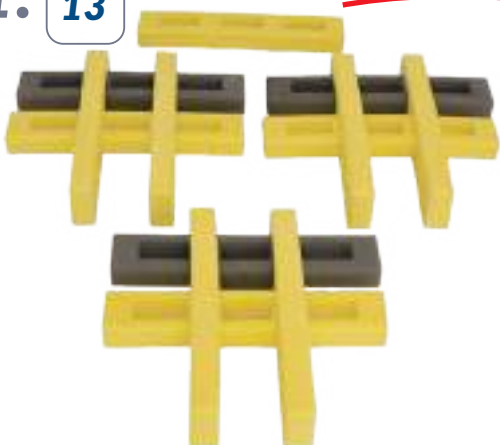

2.

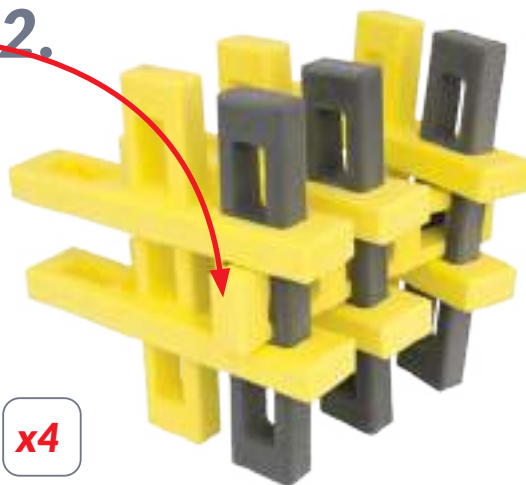

3.



4. +6



5.

+6

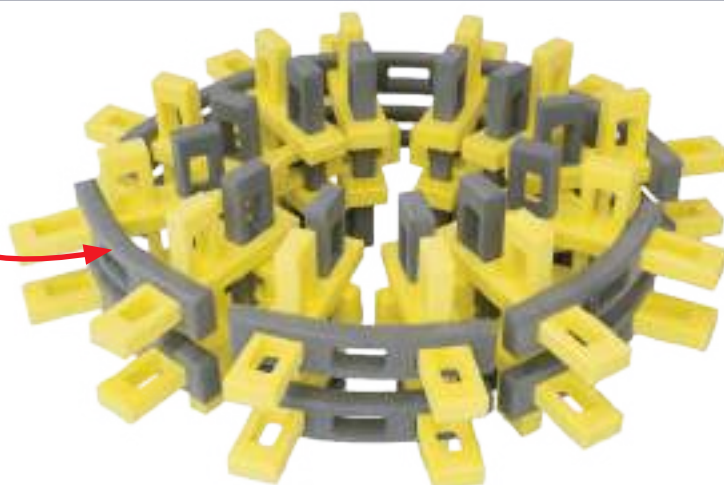

6.

+12

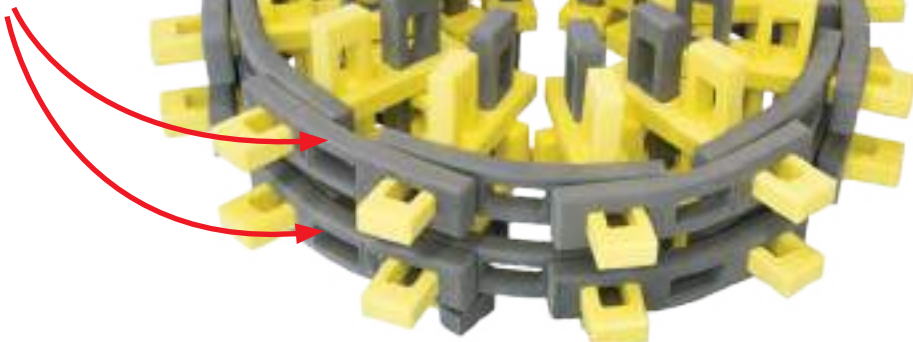

7.

+48

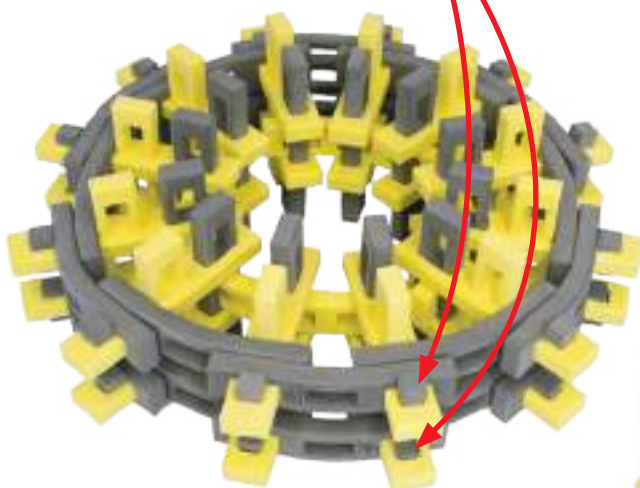

# KRZESŁO Z OPARCIEM



 **51**       **12**

**1.** **6** **x3**

**2.** **+3**

**3.** **+3**

**4.** **6** **x2**

**5.**

**6.**

**!**  
**+3**

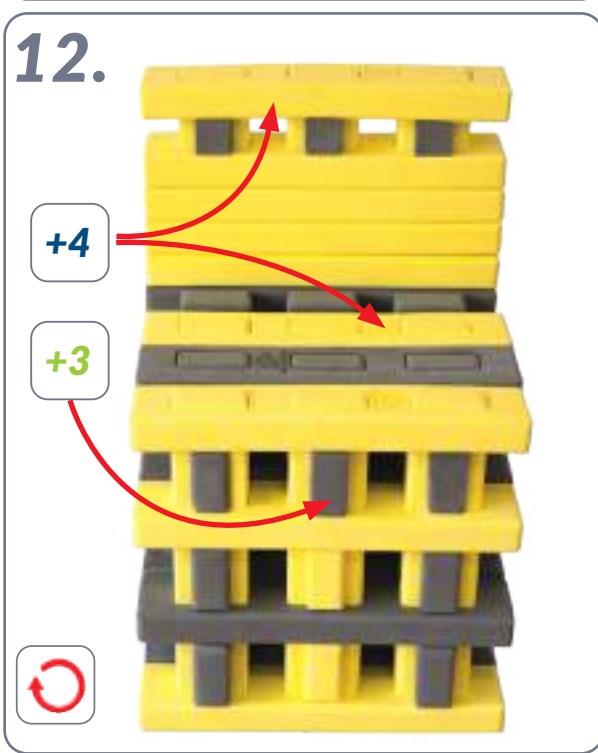
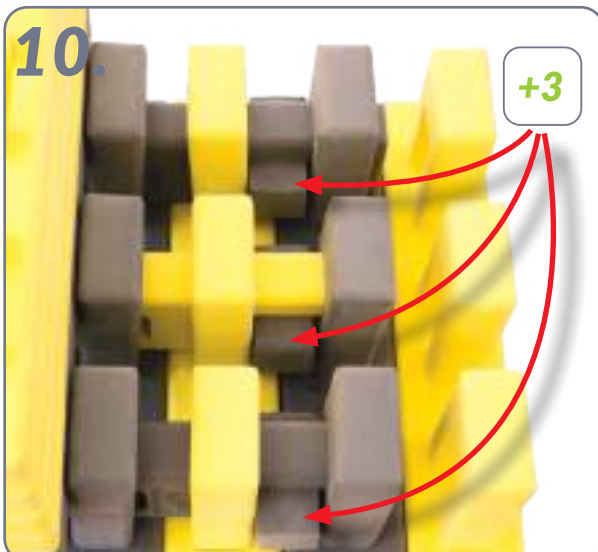
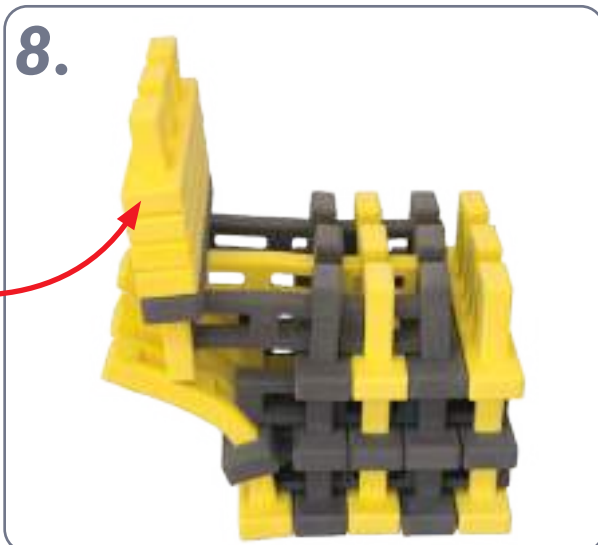

# MOTOR

 **47**       **12**



**1.** **10**

**2.**

**3.**

**+3**

**4.**

**+3**      **+2**      **+2**

**5.**

**+2**      **+3**



12.



13.



Perfect 160

# WIEŻA

 **112**  **0**



1.

16



2.

+8

x4

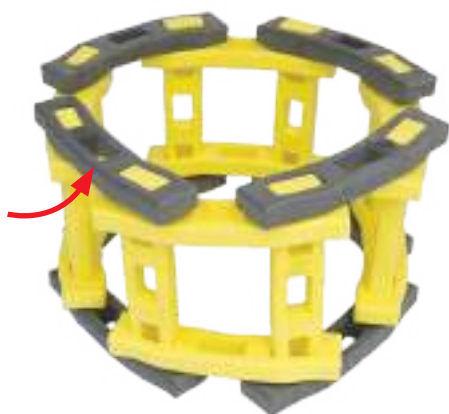

3.

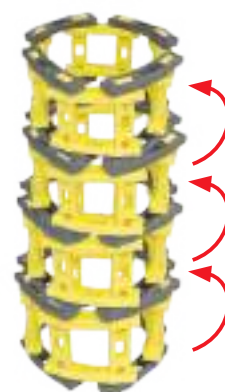

4.

16



5.



Perfect 160

# TUNEL

 **125**  **24**



1. 22

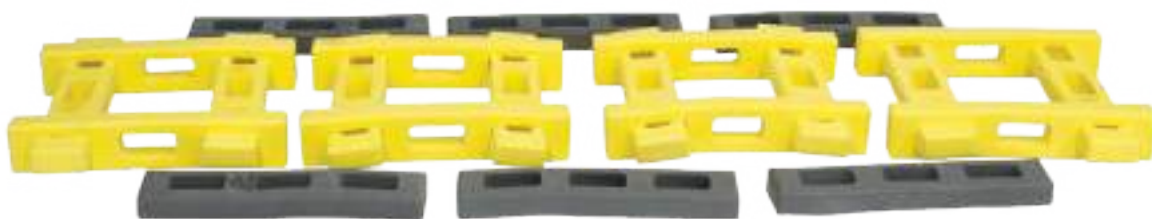

2.



3. 7



4. x4



5.



6.

+3

+6

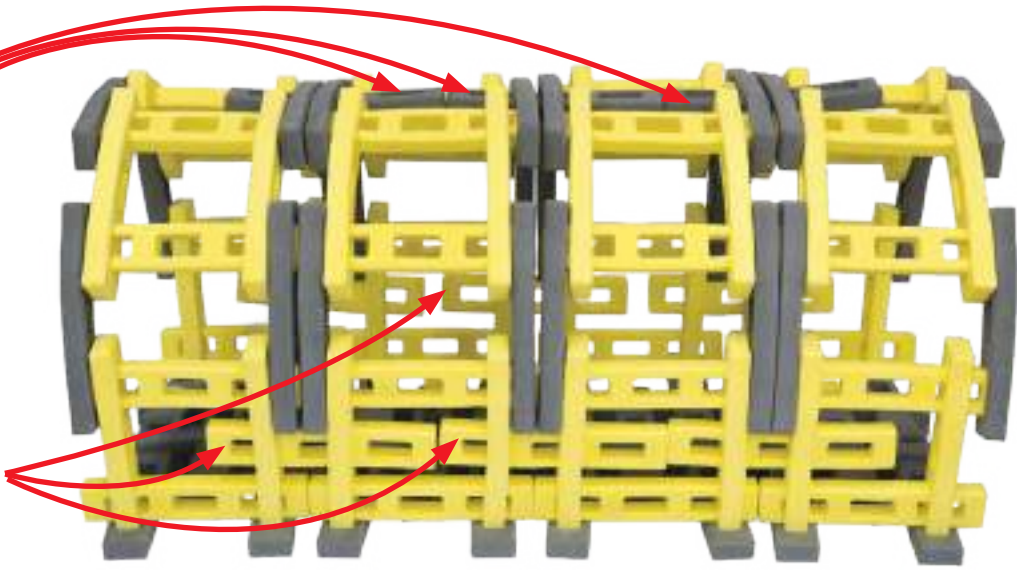

5.

+24

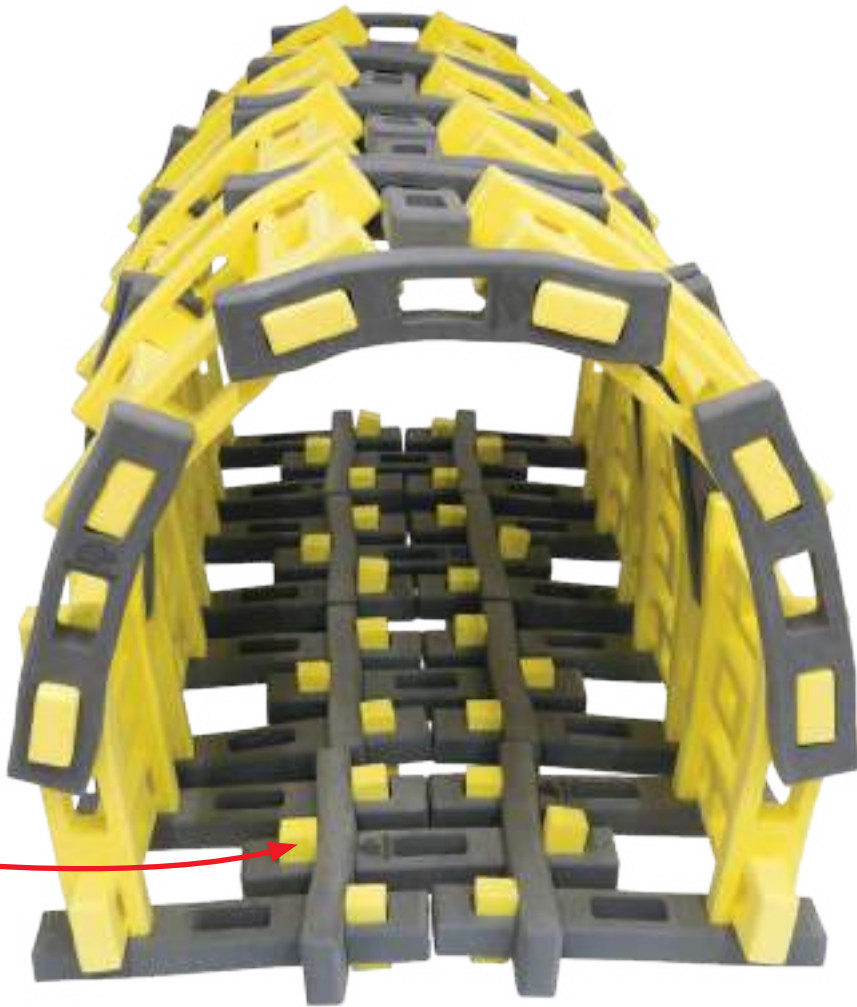

Perfect 160

# IGLOO



111



38

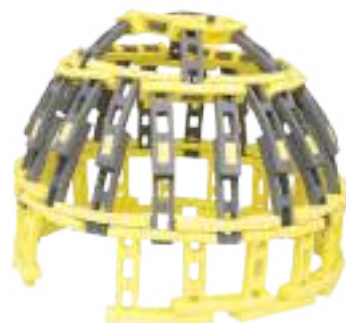

1.

17

16

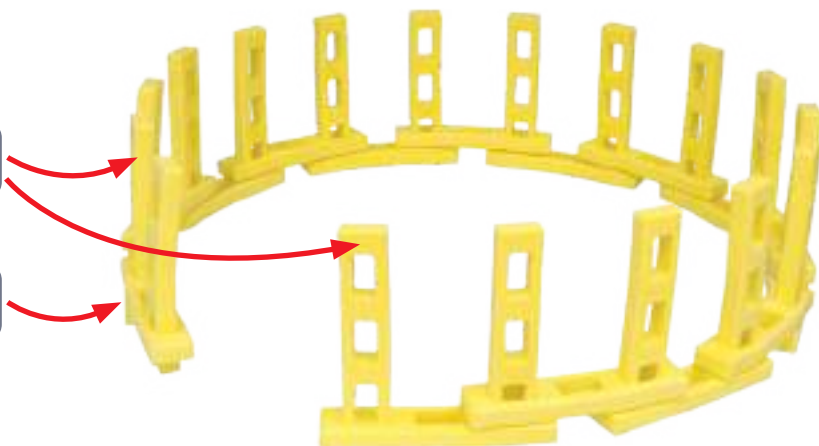

2.

+9



3.

+9

+2

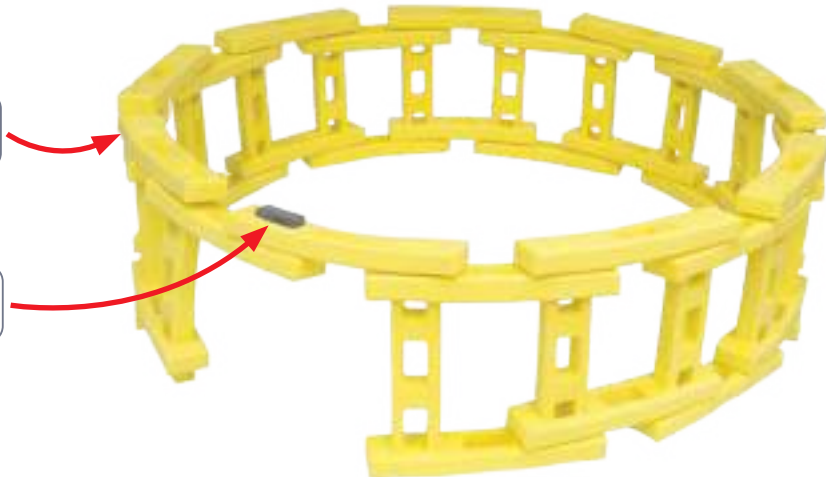

4.



5. **x18**



6.



7

**+6**



8.

+6



9.

+6



10.

+3

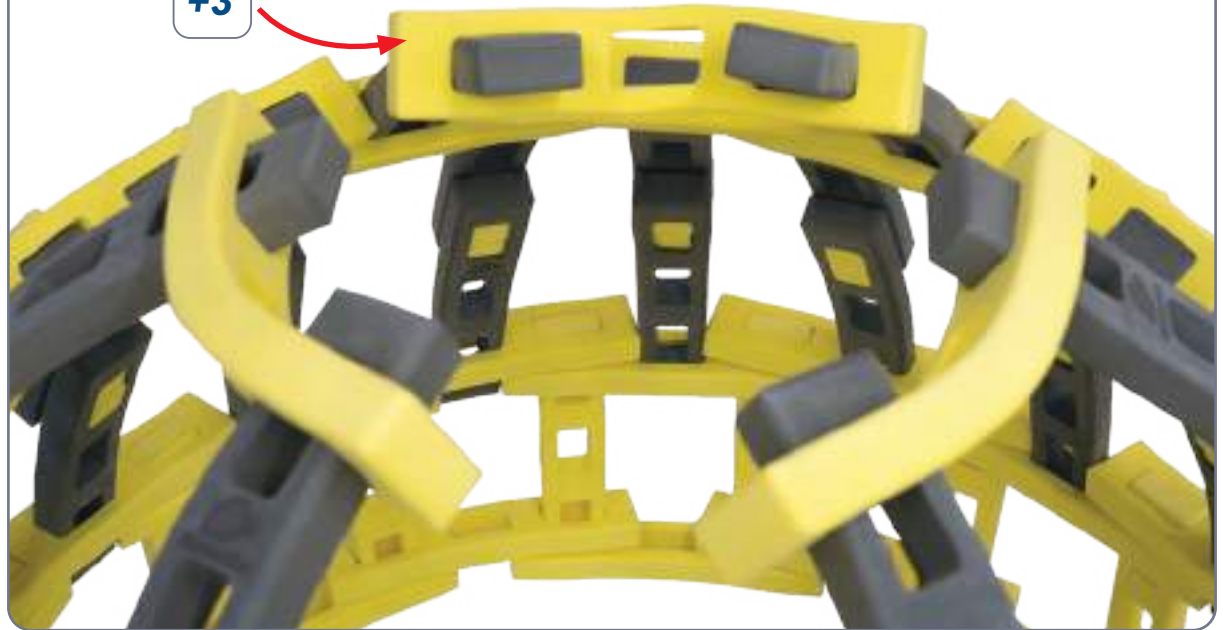

11.

+3

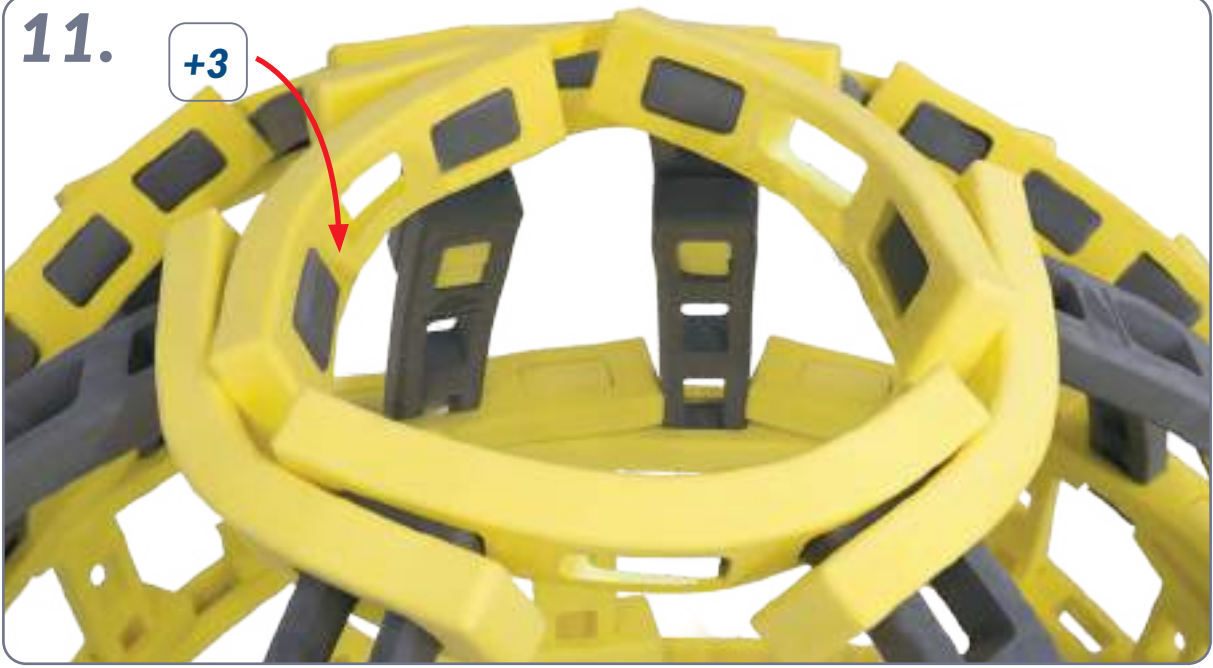

Perfect 160

# KOŁO WIELOFUNKCYJNE



116



38



1.

5

x6

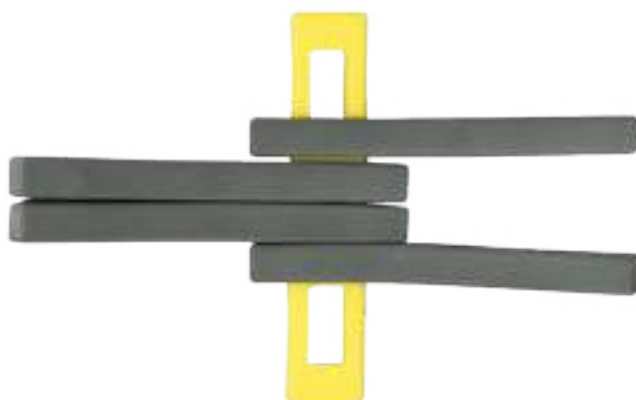

2.

+6

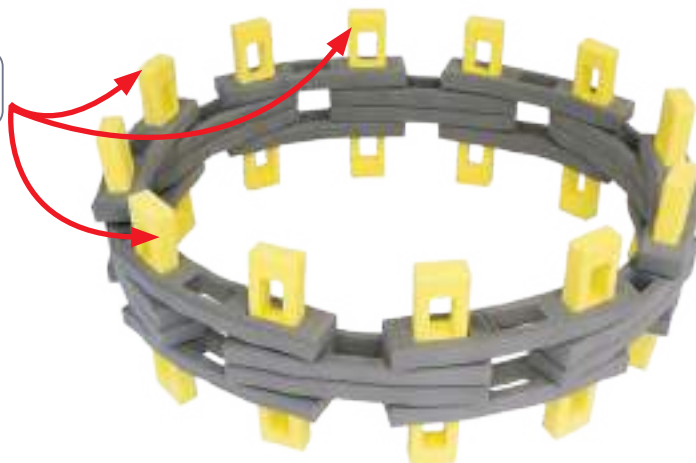

3.

+6

+6

+18

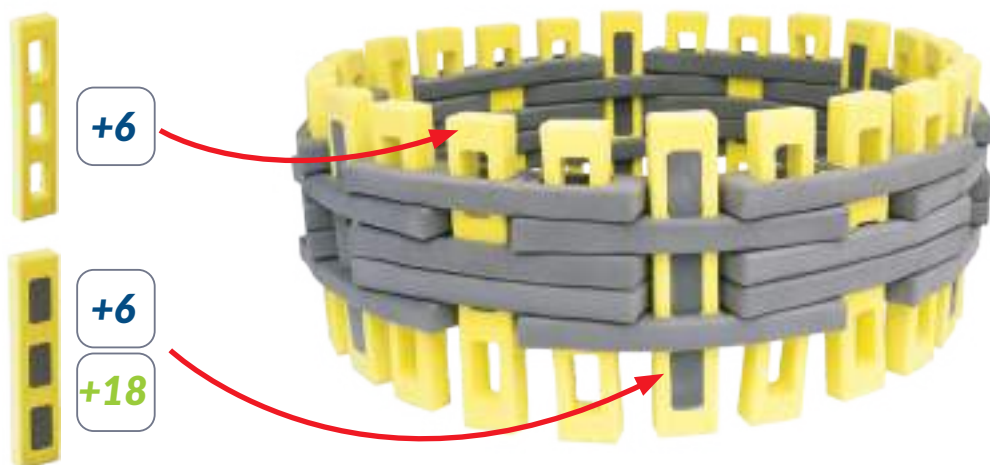

4.

+6

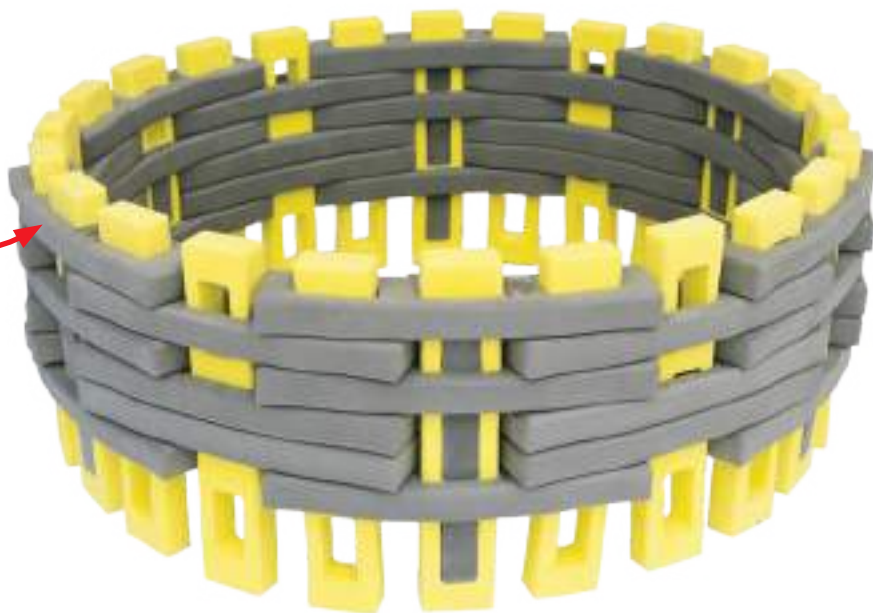

5.

+6



6.



+6



8.

+6



Perfect 160

# CIUCHCIA Z WAGONEM

 **121**  **0**



1. **13**

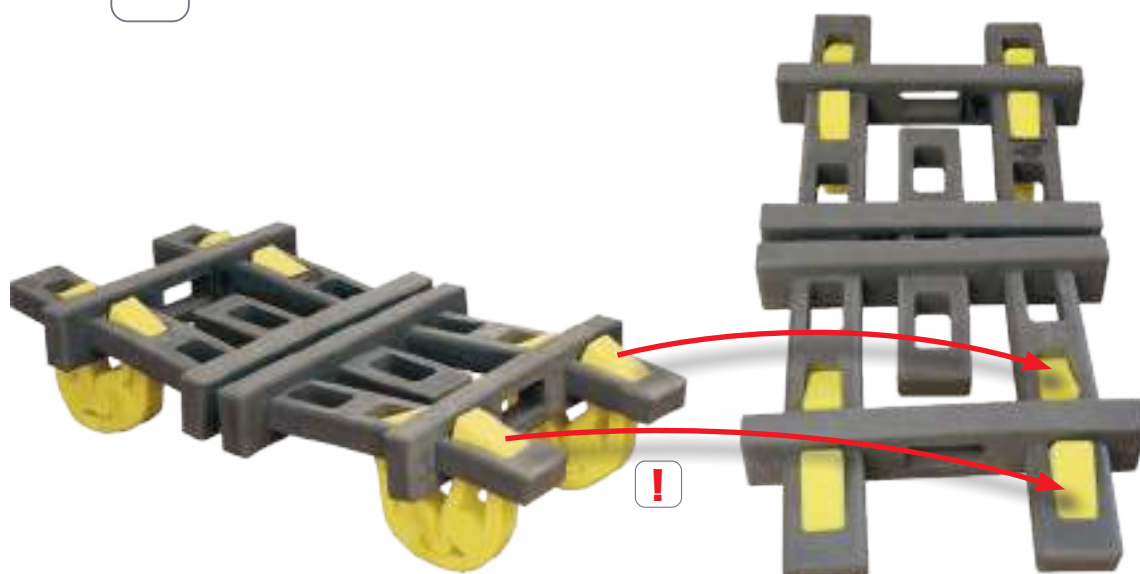

2. **30** **x2**



3. **+4**

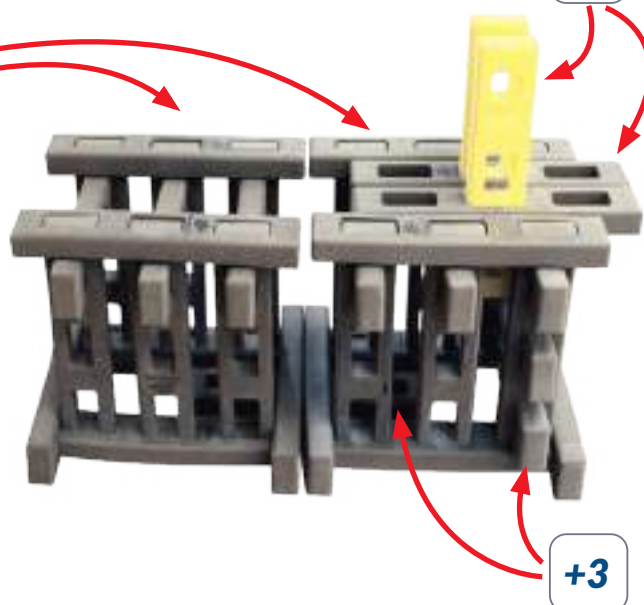

4.

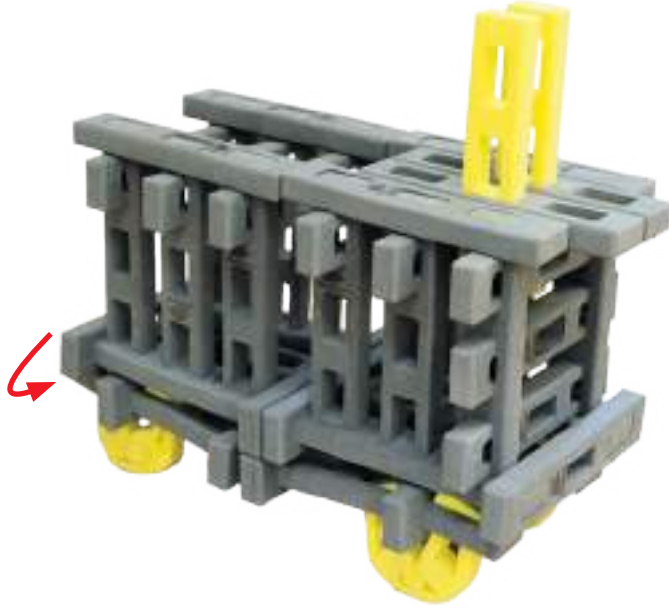

5.

18



6.



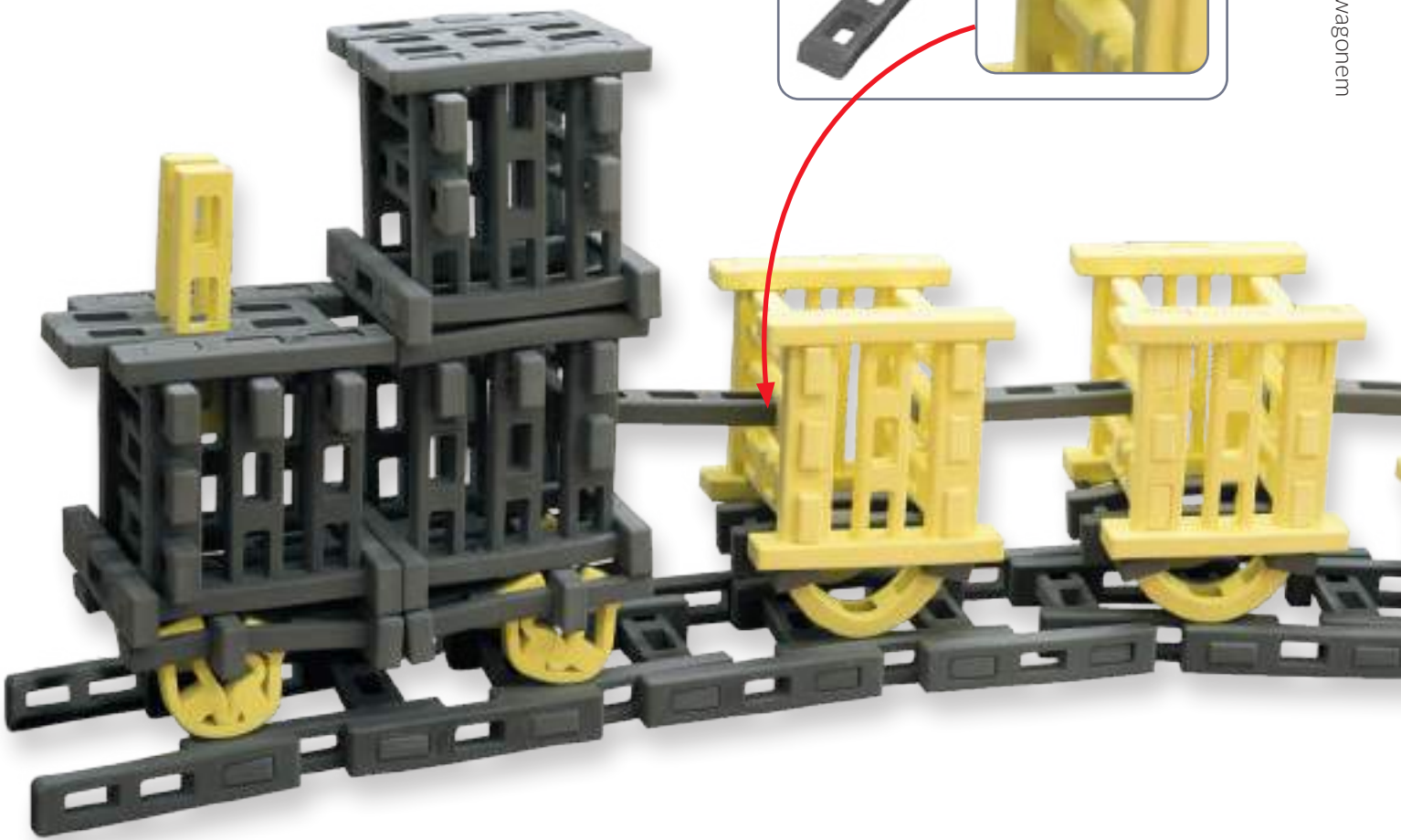
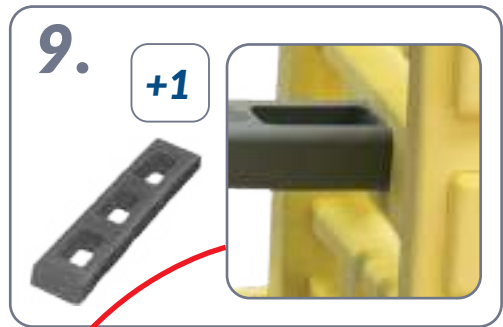

Perfect 160

# STADION NARODOWY



160



62



1.

24

x8



2.



3.

+8

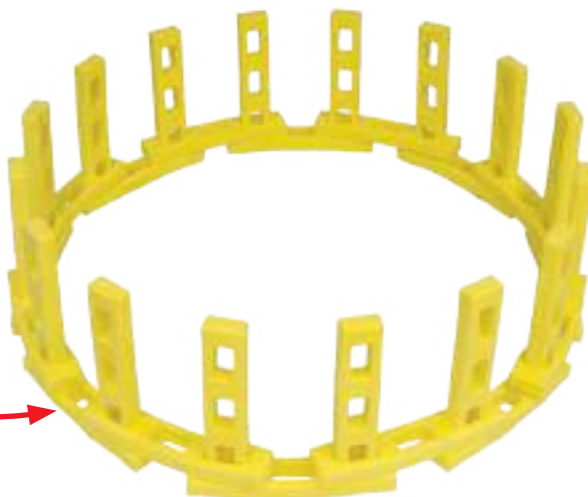

4.

+8

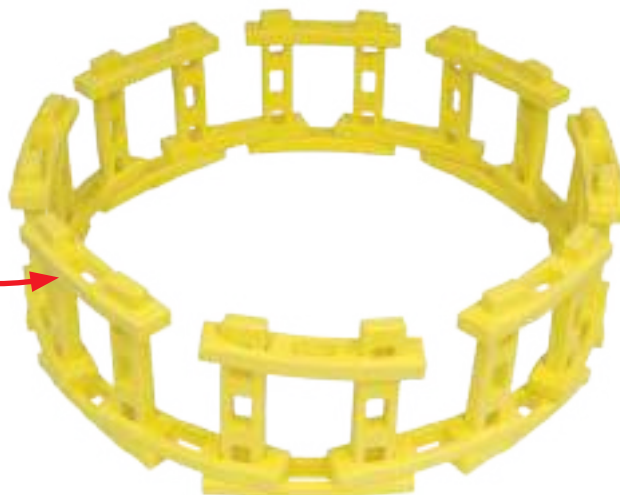

5.

+8

+16

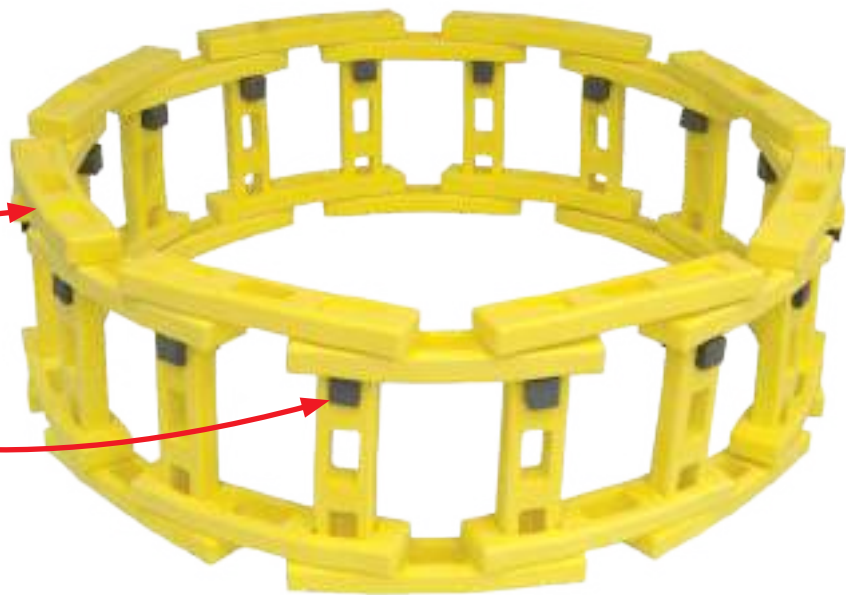

6.

x16

2

3

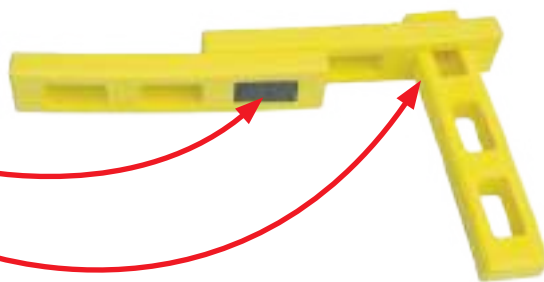

7.

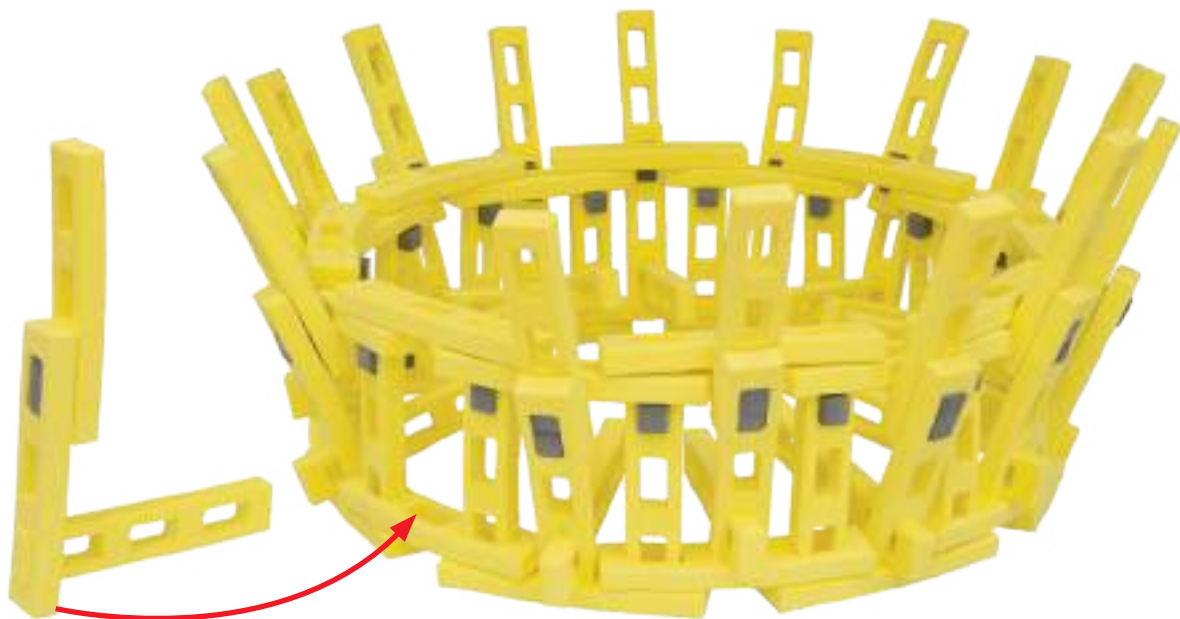

8.



+16

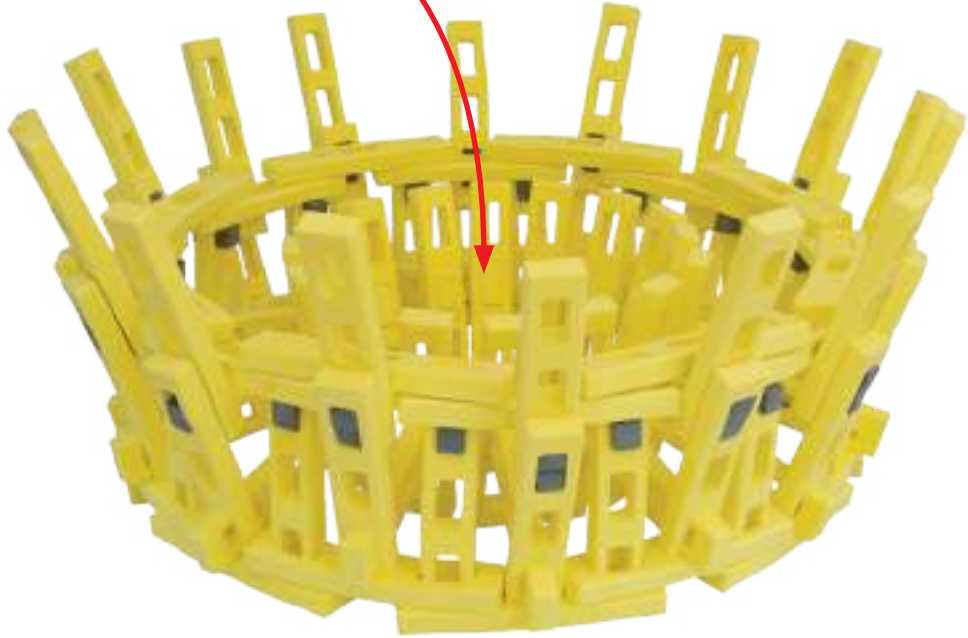

9.

21



10.

+7

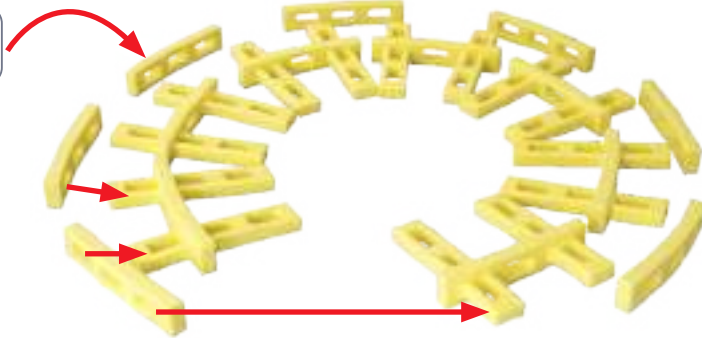

11.

+14



12.

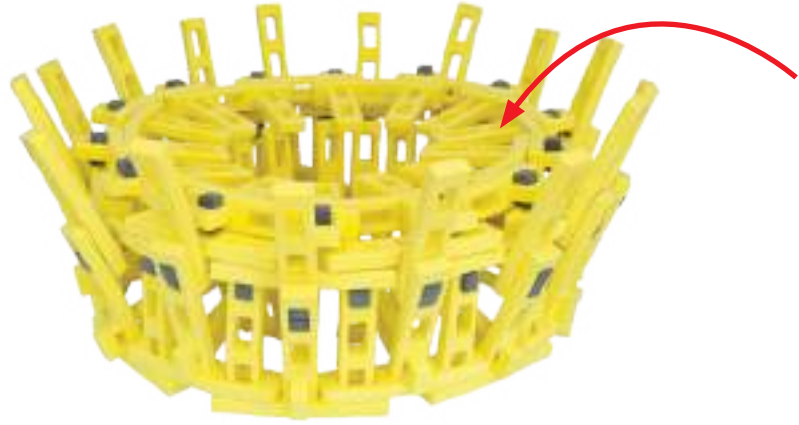

13.

+10

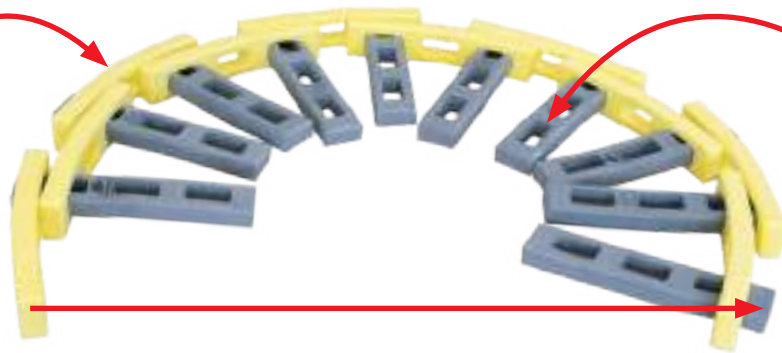

+10

14.

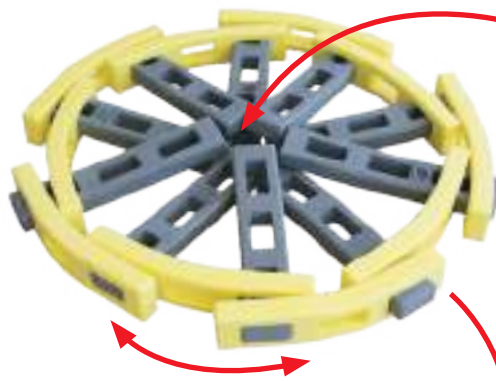

15.

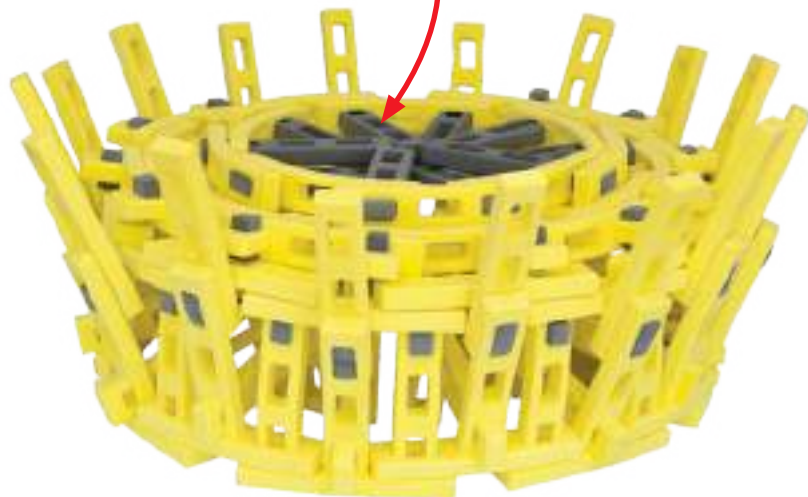

Perfect 160

# KULA



**118**



**48**



1.

12

12



2.

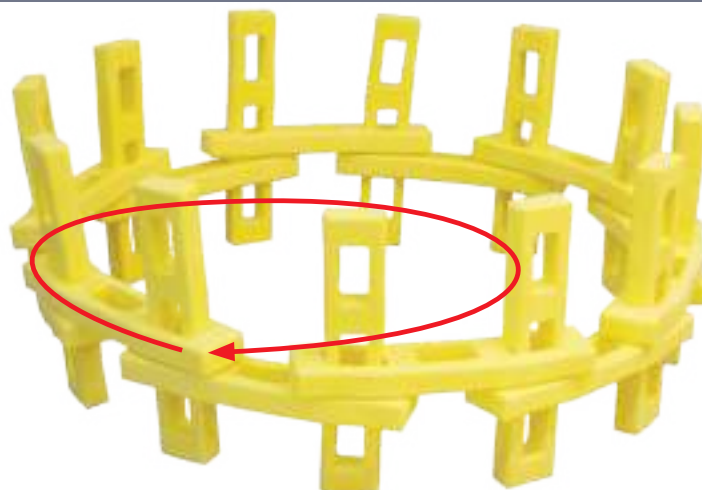

3.

+6

+6

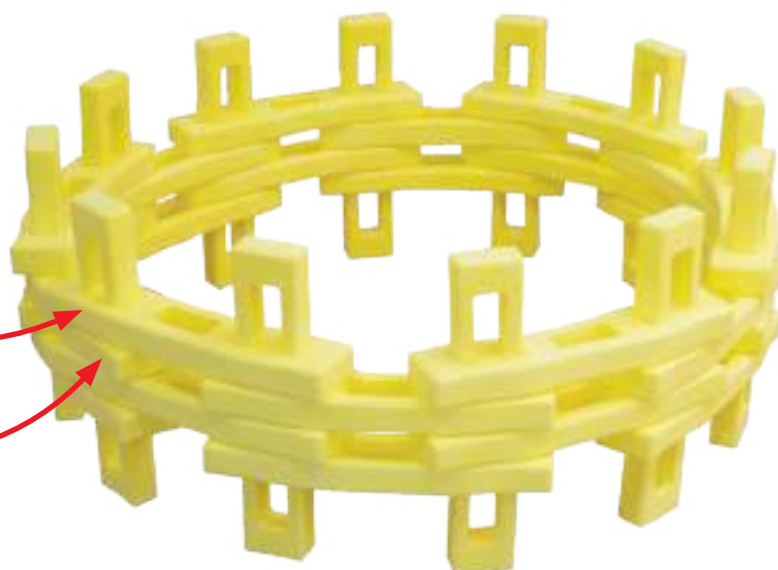

4.

+6

+6

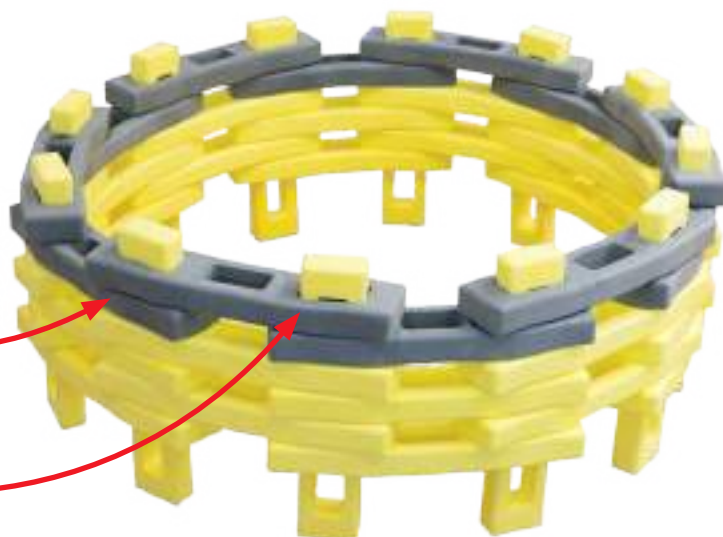

5.

+6



6.

+18



7.

20

24

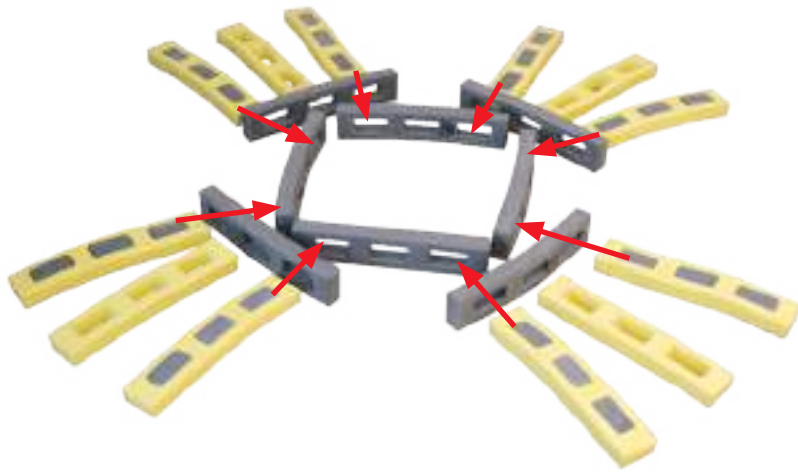

8.

x2



9.

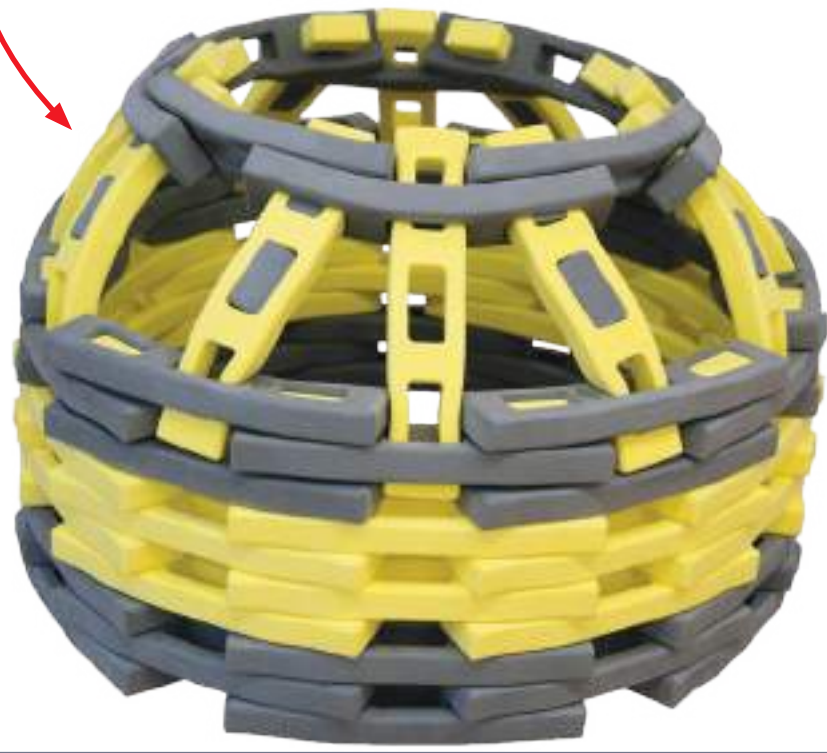

10. 

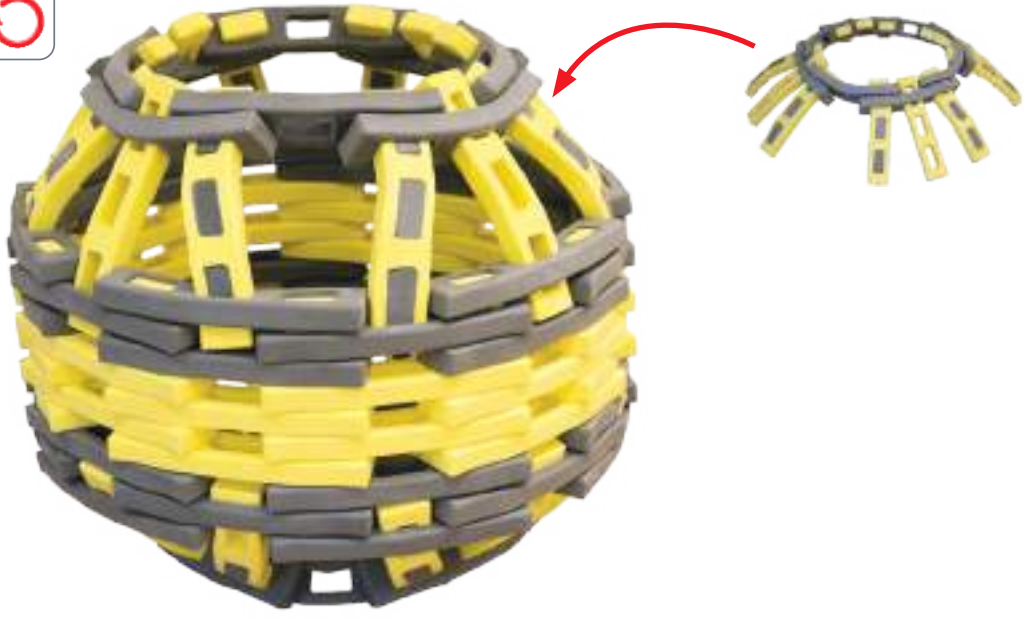

11. 

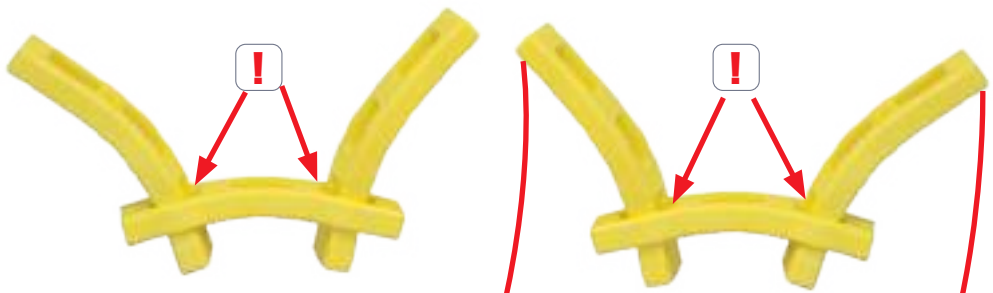

12.



13.



Perfect 160

# WIEŻA DO SUFITU



Perfect 160

# ŁUK TRIUMFALNY



104



0



1.

17 17



2.

+18 +18



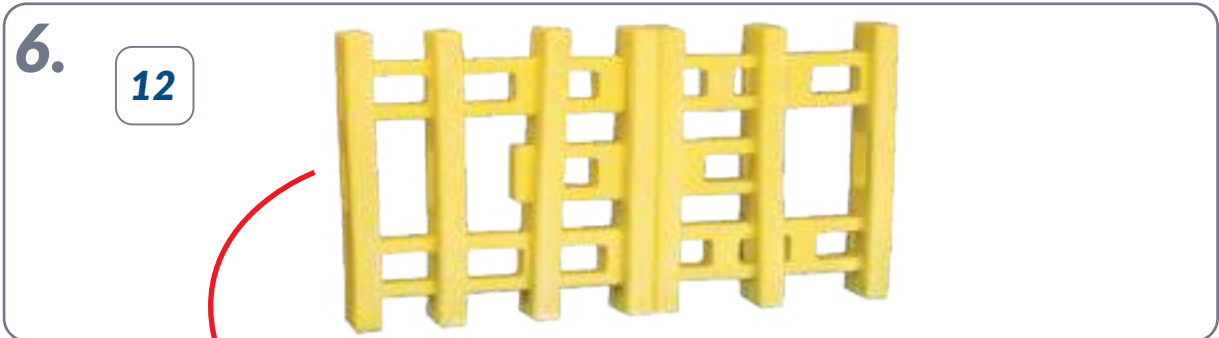
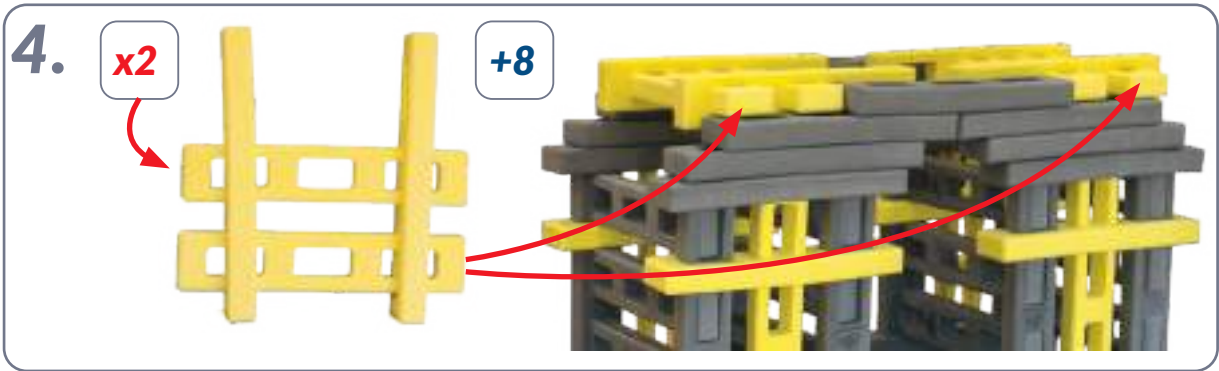
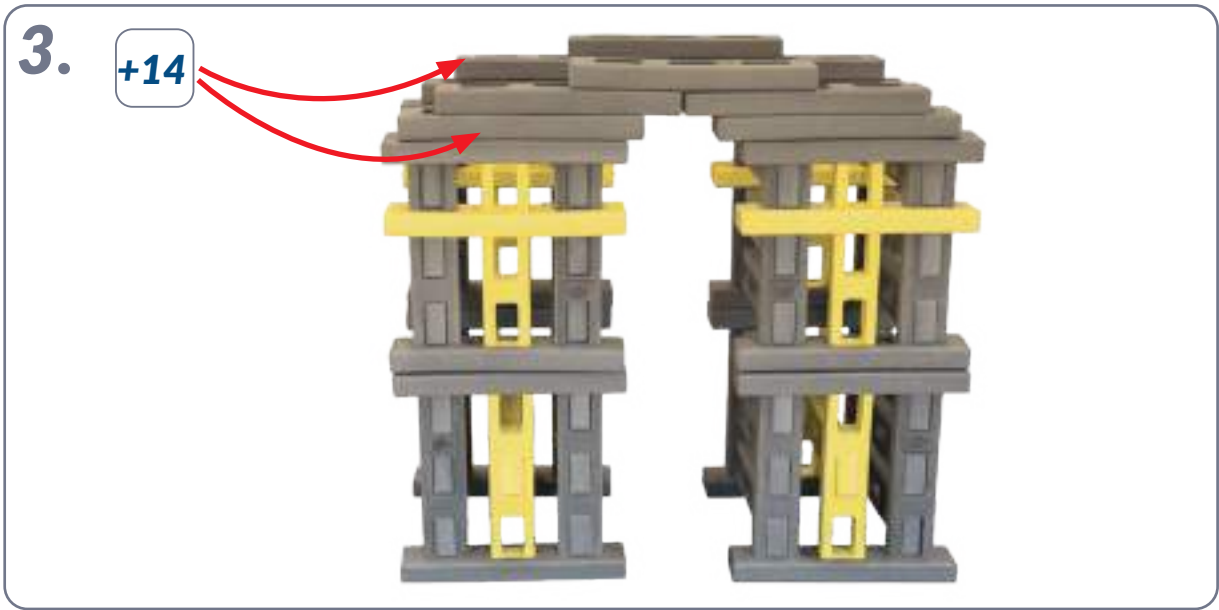

# www.perfect-blocks.com

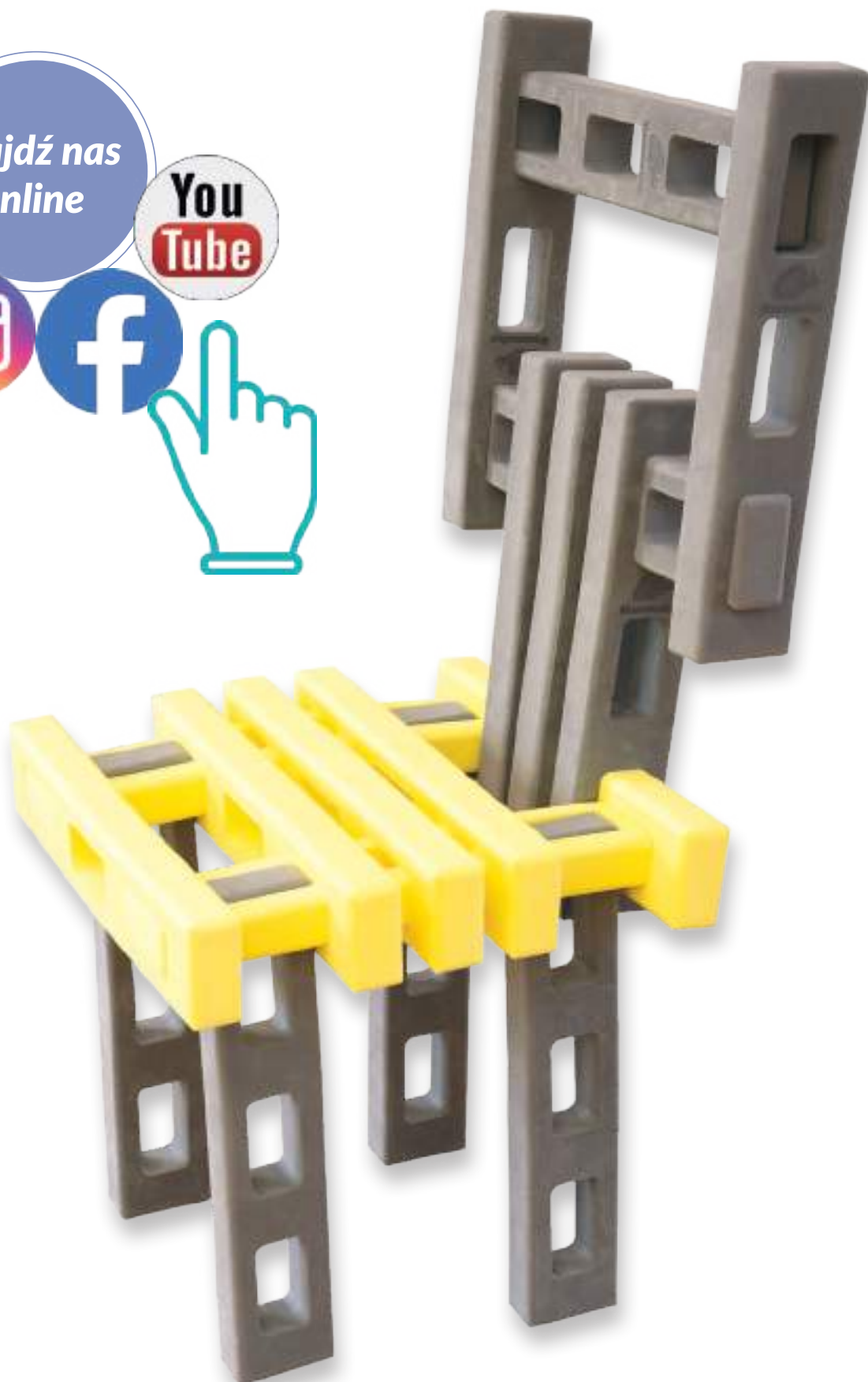

Mammuti Co. Sp. z o.o., Plac Zgody 6A, 05-820 Piastów, Polska

Mammutico® [www.mammutico.com](http://www.mammutico.com), [info@mammutico.com](mailto:info@mammutico.com), +48 729 97 37 37